

Instruction book

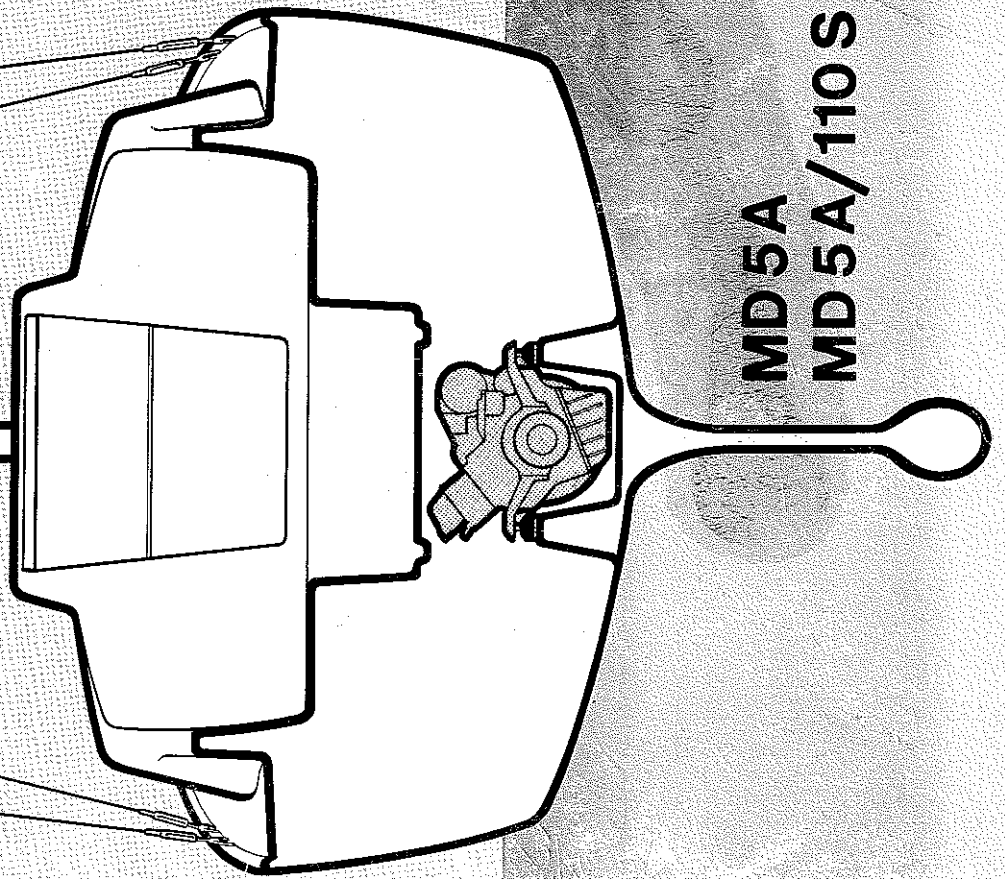

AB VOLVO PENTA
S-405 08 GÖTEBORG SWEDEN



MD 5A
MD 5A/110 S

FOREWORD

Before you start running your new Volvo Penta marine engine, you would be advised to read through this instruction book carefully. It contains all the information you need to run and service your engine in the best possible way.

Volvo Penta has built up an extensive service organization with service shops and specially trained personnel at your service.

Always contact your local Volvo Penta representative for advice and when in need of service and parts.

We are convinced that the demands on good running economy and top performance, which you have every right to expect of a quality product, will be met and that your engine will serve you faithfully on many pleasant cruises.

WARRANTY

A warranty certificate is supplied with each engine. It contains the warranty conditions for the engine and should be studied carefully.

Also included is a report card which is to be completed by the dealer or boat seller.

If our warranty is to apply, however, it is an absolute condition that the measures given in the "Check and Service Scheme" are carried out and that your engine and equipment are looked after according to the instructions in this manual. When in doubt, always get in touch with an authorized Volvo Penta dealer.

In all correspondence with your dealer and when ordering parts, state the type designation and serial number of the engine and reverse gear (see starboard side of engine).

AB VOLVO PENTA
Technical Publications Dept.

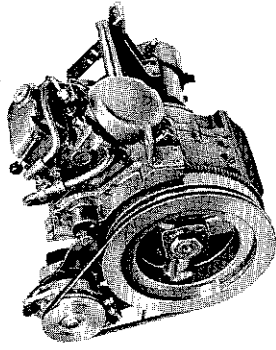

Presentation

2

General Information

3-4

Running Instructions

5-6

Starting the engine

Running instructions

Shutdown procedure

7-9

Technical Description

Checks and Service Scheme

10

Checks and Service

11-17

Check daily before starting

Check every 14 days

Service every 50 hours of operation

Service every 100 hours of operation

Laying-up and launching

20-23

Fault Tracing Scheme

24

Technical Data

25-26

Wiring Diagram

27

Engine Component Guide

28-29

S-drive 110S

30-32

On Board Data

33

Index, alphabetical order

34

PRESENTATION

INSTRUMENT PANEL

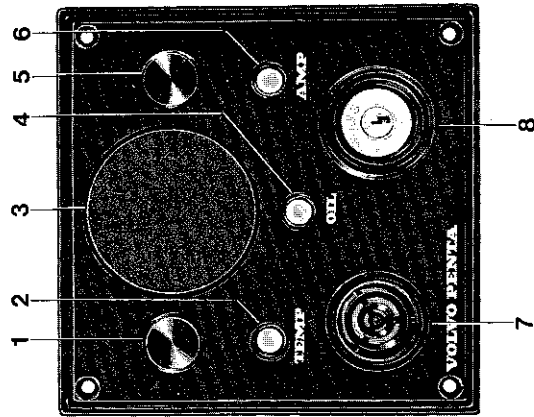

1. Switch, optional equipment
2. Warning lamp, "Excess temp."
3. Place for instrument (Ø 52 mm opt. equipment)
4. Warning lamp, "No oil pressure"
5. Switch, optional equipment
6. Warning lamp, "No battery charging"
7. Siren, "No oil pressure, excess temp."
8. Key switch

CONTROL SYSTEM

Volvo Penta Singel Control System

For side mounting

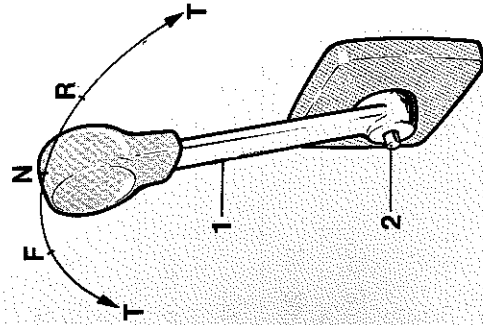

1. Control lever
2. Disengaging button

Push in the button when the control lever is in neutral and move the lever a bit forwards. Release button. The lever is now used only for engine speed control.

To use the lever for both engine speed control and gear shifting, pull back the lever to neutral position and move it again "Forward" or "Reverse".

F = Control lever in position for running "Forward"

R = Control lever in position for running "Reverse"

T = Engine speed control

GENERAL INFORMATION

Important information on the function of your engine:

FUEL

Use diesel fuel oil of quality "Autodiesel" Poorer fuel quality can cause interruptions in operation.

LUBRICATING OIL

Use only oil with quality CD (DS) according to the API system. Volvo Penta oil for diesel engines can be used with advantage since it meets these quality demands. See under "Technical Data" concerning the viscosity.

RUNNING-IN

A new marine engine must be run-in with due care during the first 20 hours of operation. If full output is taken out during this time, it should only be done for short periods.

Oil change. Change the engine lubricating oil and the oil filter after the engine has been run for 20 hours. See further under "Checks and Service".

ENGINE SPEED

Max. speed: 41.7 rev/sec (2500 rev/min).

For choice of correct propeller, refer to the Volvo Penta propeller diagram. Check the engine speed with normal load in the boat. In order to utilize the maximum performance of the engine, an engine speed as high as possible should be chosen but not, however, greater than 41.7 rev/sec (2500 rev/min).

NOTE. When the boat has been in the water for some time, the speed and max. rev/min can drop due to marine growth on the hull. Prevent marine growth by painting the bottom of the boat with anti-fouling paint. See under "Measures taken when launching".

GENERAL INFORMATION

SAFETY EQUIPMENT

Irrespective of whether the boat is being used for long cruises or short bathing trips, the boat should be equipped with the safety equipment listed below. It can, of course, be supplemented further according to personal tastes. Investigate at regular intervals to ensure that there is safety equipment on board and that it is in working order.

LIFE-JACKETS for all on board.

FIRE EXTINGUISHER, approved, at least one and installed where it is easy to get at.

DISTRESS ROCKETS and matches. Packed watertight.

FIRST-AID BOX

TOOLS suitable for the equipment on board.

ON BOARD KIT containing, e.g. impeller, etc.

ANCHOR with line.

RADAR REFLECTOR

RADIO for listening to, e.g., weather reports.

COMPASS which is deviated.

BOAT HOOK and paddle.

MOORING ROPES

FOG-HORN and whistle.

FLOATING ANCHOR

TORCH

PREPARATIONS BEFORE STARTING

Make sure that:

There is no **FUEL LEAKAGE**

There is no **WATER LEAKAGE** from engine and hull

There is no **OIL LEAKAGE**

There is no **SMELL OF LP-GAS** in the deep cavities in the boat or elsewhere

The **OIL LEVEL** is correct

There is enough **FUEL** for the planned voyage









The proper **NAUTICAL CHARTS** are on board for the planned voyage

If there are some other persons on board, make sure that some of them is able to operate the boat.

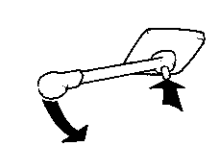
If there are persons on board who have never been on a boat before, tell them where the life-jackets are located and where the fire-extinguisher is placed. Also tell them anything more you think necessary from a safety point of view. Should something unexpected happen during the voyage, it is very often too late to tell those on board how safety equipment works.

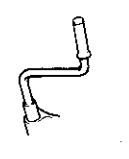
RUNNING INSTRUCTIONS

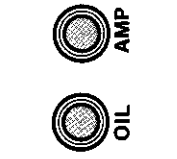
STARTING THE ENGINE

	Switch on the main switch . Start the engine room fan (if fitted) and let it run several minutes before starting the engine.
	Open the cock for the cooling water intake. Pump out eventuell water with the bilge. pump.
	Disengage the engine speed control from the gear-changing as follows: Move the control lever to neutral, push in the red disengaging button, and move the lever slightly forwards. Release the button. The lever can now only operate the engine speed. Check to make sure that the stop control is pushed in.
	Turn the key switch one stage to the right. The warning lamps for battery charging and oil pressure should now go on and the siren should sound. Push in and turn the key further to the right to start the engine. Release the key when the engine starts.
	Hand starter. (Not MD 5/110S) If the engine is started with the starting crank, the decompression handle on the rocker arm cover should first be folded up. Fold down this handle for running when the cranking has got the engine up in speed.
	Starting in cold weather is facilitated if the cold-start control is pulled out. Push it in again after a while.
	Check immediately after starting that the warning lamps for the oil pressure and battery charging are out and that the siren is quiet. If any of the lamps are on and the siren is sounding, the engine must be stopped immediately and an investigation made.
	Run the engine warm at rapid idle. Check to make sure that the cooling water flows out with the exhaust gases. NOTE. The key switch should always be switched on as long as the engine is running to ensure that there is battery charging.



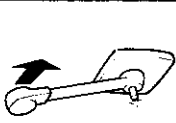

RUNNING INSTRUCTIONS

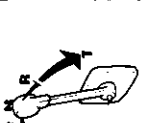
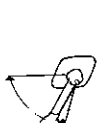
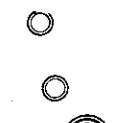
	<p>Reduce to idle and check that the engine is running smoothly.</p> <p>Engage the control lever for gear-changing as follows:</p> <p>Pull the lever back to neutral. The control lever can now be used both for gear-changing and engine speed.</p>
---	---

RUNNING

	<p>The single lever control has both engine speed and maneuvering functions.</p> <p>F = Forward N = Neutral R = Reverse T = Engine speed control</p> <p>Note! If the boat is supplied with a folding propeller, the engine speed must be reduced to idling before shifting "Forward." (See page 35).</p>
	<p>To achieve good running economy, the engine should not be run at max. speed for a longer period.</p>
	<p>Make sure that the battery charging warning lamp does not light when the engine is running. The siren will sound and the respective warning lamp go on if the engine temperature becomes excessive or the oil pressure too low.</p>

SHUTDOWN PROCEDURE

	<p>After shutdown the engine should be allowed to idle for a couple of minutes or so with the control lever in neutral.</p>
	<p>Stop the engine by pulling out the stop control when the engine is idling. Then turn back the key switch to the initial position.</p>
	<p>Switch off the main switch. NOTE: This switch must never be switched off until the engine has stopped.</p> <p>Close the fuel and cooling water cocks if the boat is not going to be used for some time.</p> <p>Check for leakage before leaving the boat.</p>
	<p>In cold weather and whenever there is risk of icing, the cooling water should be drained from the engine and reverse gear. See under "Laying-up and launching".</p>

TECHNICAL DESCRIPTION

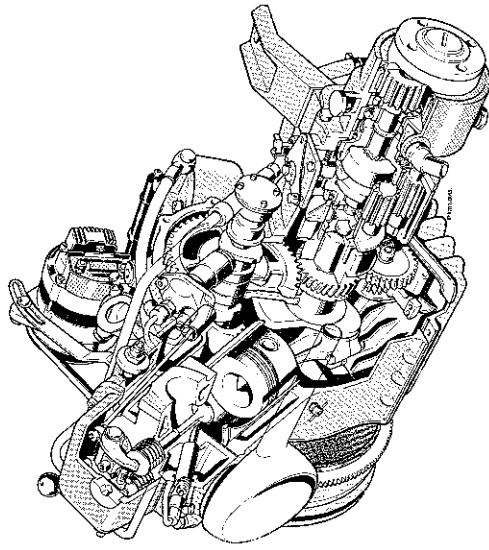

The MD5A is a single-cylinder, 4-stroke, marine diesel engine with direct injection and sea-water cooling.

ENGINE ASSEMBLY

The engine block and cylinder head are made of cast iron. Cylinder angle 45°. The cylinder liner is replaceable. The engine has overhead valves.

LUBRICATING SYSTEM

The lubricating system includes a full-flow oil filter which filters all the oil before it reaches the lubricating points. A relief valve in the oil pump prevents the oil pressure from becoming excessive.

ELECTRICAL SYSTEM

The engine has a starter motor and alternator with built-in rectifier. Voltage regulation is taken care of by a transistorized regulator mounted on the alternator. The alternator makes it possible to charge two battery circuits independent of each other if a charging distributor (accessory) is fitted on the alternator.

A main fuse, which can easily be re-connected, is fixed to the engine. It protects the electrical system from damage in the event of overloading. The wiring diagrams for the engine and instrument panel are shown on page 27.

TECHNICAL DESCRIPTION

FUEL SYSTEM

The fuel system contains a feed pump with pre-filter, fine filter, injection pump and injector. The feed pump, which is of the diaphragm type, has also a hand priming lever. Also fitted is a cold-start device with lever for connection of the push-pull control.

COOLING SYSTEM

The engine is sea-water cooled. The cooling system includes a sea-water pump as well as a water distributor housing with thermostat.

The sea-water pump has an impeller of neoprene rubber driven by the camshaft via a rubber flange.

The thermostat installed in the water distributor housing regulates the water flow so that the water always flows through the exhaust manifold and out into the exhaust elbow irrespective of whether the engine is cold or warm.

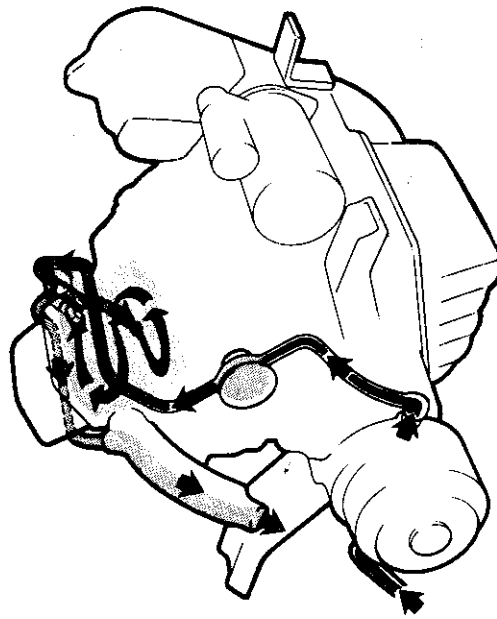

TECHNICAL DESCRIPTION

REVERSE GEAR

The Volvo Penta reverse gear, type Mono Shift (MSB) has a reduction ratio of 1.91:1. The reduction gear is integrally built with the reverse gear. Power transmission from the engine to the reverse gear is via a rubber flange.

The Volvo Penta patented cone clutch is used for "Forward" and "Reverse" operation and ensures smooth and quiet engagement. Very small forces are required to operate the reverse gear.

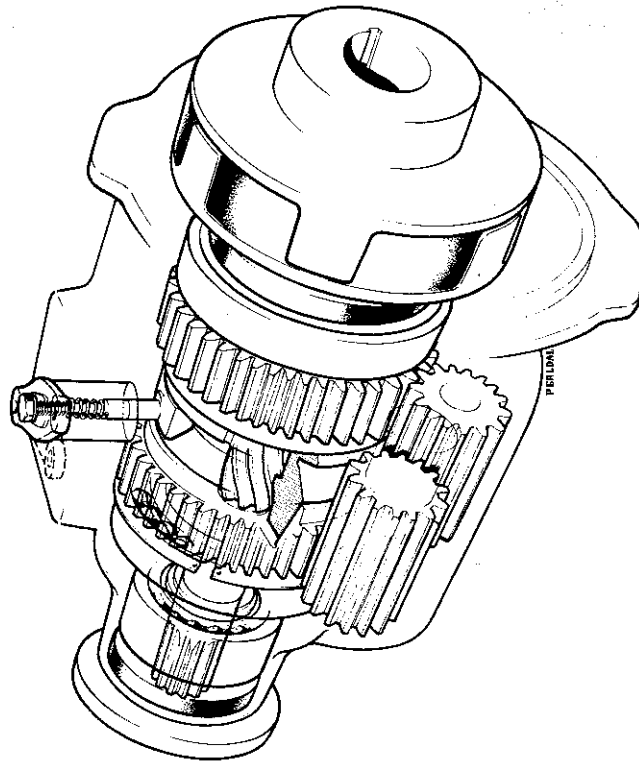

CHECKS AND SERVICE SCHEME

Checks and service should be regularly carried out according to the intervals given below. Let an authorized Volvo Penta Service Shop look after your engine.

CHECK DAILY BEFORE STARTING that

Page
11

The oil level in the engine is between the marks on the dipstick

CHECK every 14 days that

- 11 The oil level in the reverse gear is between the marks on the dipstick
- 12 The electrolyte level in the battery is correct
- 12 The belt tension

SERVICE EVERY 50 HOURS OF OPERATION:

- 12 Change the oil in the engine
- 13 Change the oil in the reverse gear (every 200 hours)
- 13 Check and adjust the valve clearance

SERVICE EVERY 100 HOURS OF OPERATIONS OR AT LEAST ONCE EACH SEASON:

- 13 Change the oil filter
- 14 Check the pulley belt
- 15 Check-tighten the cylinder head bolts
- 15 Check the cooling system
- 16 Check the electrical system (fuses, etc.)
- 17-19 Fuel system, filter, strainer, injector, venting

SERVICE IN CONNECTION WITH LAYING-UP AND LAUNCHING THE BOAT

- 20 Inhibiting Scheme. Measures carried out with boat on land.
- 22 Service in connection with launching.

CHECKS AND SERVICE

CHECK DAILY BEFORE STARTING

OIL LEVEL IN ENGINE

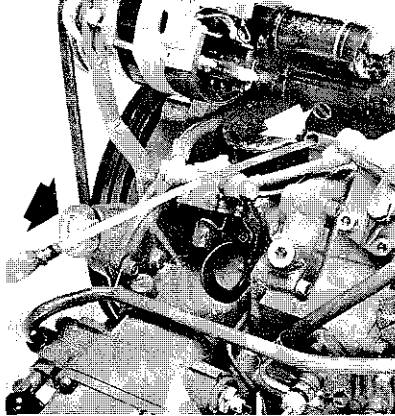

Each day before starting check that the oil level is between the marks on the dipstick. Top up with oil if necessary through the oil filler hole.
NOTE. Do not top up above the MAX. mark. Concerning choice of oil, see under "Technical Data"

CHECKS every 14 days

OIL LEVEL IN REVERSE GEAR

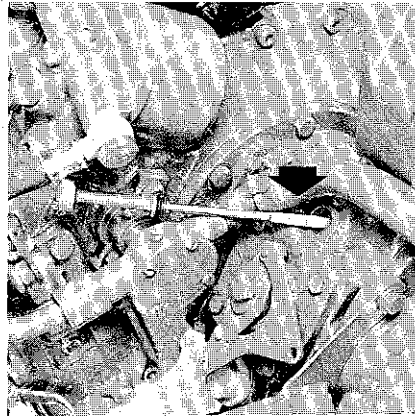

Screw up the dipstick, wipe it clean and insert it again without screwing it down. Pull up the dipstick and check the oil level which should be between the marks. If necessary top up with oil through the oil filler hole on the opposite side of the reverse gear. Do not top up above the MAX. mark.

Screw down the dipstick again. Note that there is a sealing washer on the dipstick. Concerning choice of oil, see under "Technical Data"

CHECKS AND SERVICE

ELECTROLYTE LEVEL IN BATTERY

The level should be between 5–10 mm (3/16–3/8") above the cell plates in the battery. If necessary top up with distilled water. **IMPORTANT.** Observe great care when doing this since the electrolyte is abrasive and the gas which is formed is explosive.

BELT TENSIONING

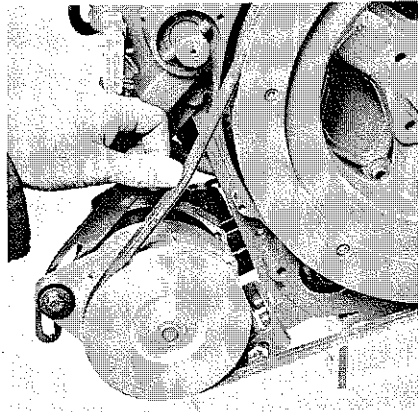

Correct belt tensioning is necessary for full alternator output. The belt should be so tensioned that it can be depressed 5 mm (3/16") with the thumb midway between the pulleys.

To tension the belt, first slacken the alternator retaining points, stretch the belts and tighten up the points again.

A well worn or cracked belt should be replaced.

SERVICE EVERY 50 HOURS OF OPERATION

CHANGE OIL IN ENGINE

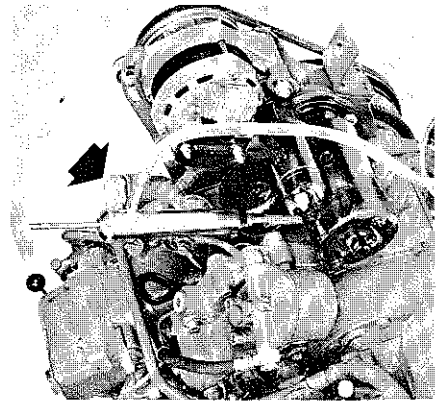

With a new or newly reconditioned engine, the oil should be changed for the first time after 20 hours of operation and after that after every 50 hours of operation.

Run the engine warm. Suck up the oil through the dipstick hole.

Fill with oil to the correct level. See under "Technical Data" concerning choice of oil.

NOTE! Change also the oil filter at every other oil change.

CHECKS AND SERVICE

OIL CHANGE IN REVERSE GEAR (every 200 hours)

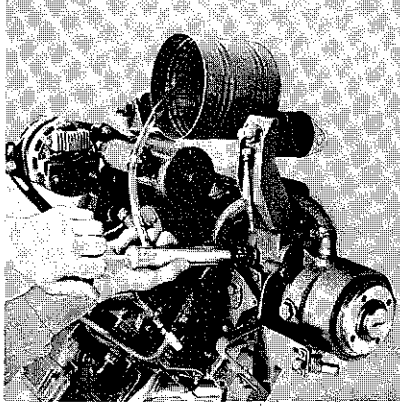

The oil can be drained from the reverse gear by removing the plug under it or by sucking up the oil through the dipstick hole with the help of an oil scavenging pump.

Fill with oil through the filler hole to the correct level on the dipstick. **NOTE.** Do not fill above the MAX. mark on the dipstick. Concerning choice of oil, see under "Technical Data".

VALVE CLEARANCE

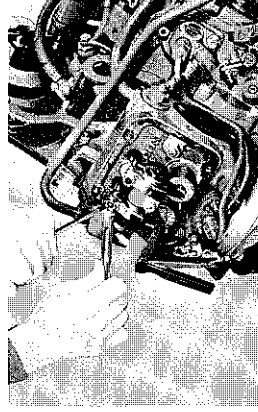

The valve clearance should be checked and adjusted by authorized personnel. See under "Valves", in "Technical Data".

SERVICE EVERY 100 HOURS OF OPERATION OR AT LEAST ONCE EACH SEASON

OIL FILTER

The oil filter should be replaced for the first time after 20 hours of operation during the running-in period and subsequently at every other oil change. **IMPORTANT.** Before removing the filter switch off the main switch. Screw off and scrap the oil filter. It may be necessary in certain cases to lift off the belt and tension out the alternator to permit free passage for the filter.

CHECKS AND SERVICE

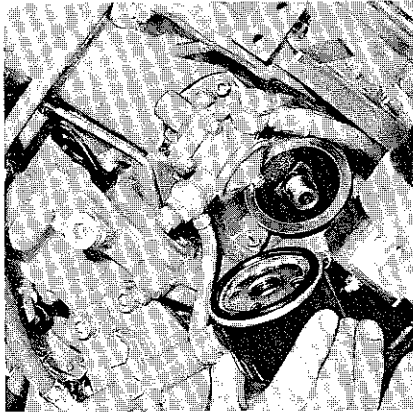

Coat the new filter rubber gasket with oil. Check the area on the engine in contact with the filter and screw on the filter **by hand** until it just touches the engine. Then screw the filter a further **half turn, but not more.**

NOTE. Only use a genuine oil filter.

Start the engine, allow it to idle and immediately check that the oil pressure warning lamp is out.

Check the oil level and also for any leakage round the oil filter.

CHECKS AND SERVICE

CHECK-TIGHTEN CYLINDER HEAD BOLTS

Authorized personnel should check-tighten the bolts **with a torque wrench** after it has been in operation for 20 hours.

Check the valve clearance after tightening up the bolts. The bolt-tightening sequence can be seen from the adjacent illustration.

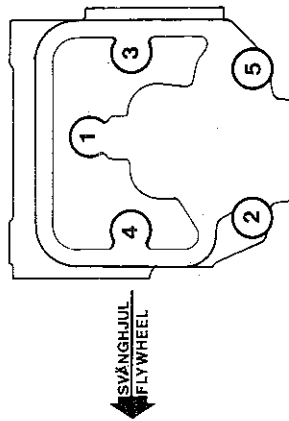

Concerning the tightening torque, see under "Technical Data".

CHECKS AND SERVICE

Coat the new filter rubber gasket with oil. Check the area on the engine in contact with the filter and screw on the filter **by hand** until it just touches the engine. Then screw the filter a further **half turn, but not more.**

NOTE. Only use a genuine oil filter.

Start the engine, allow it to idle and immediately check that the oil pressure warning lamp is out.

Check the oil level and also for any leakage round the oil filter.

CHECK THE COOLING SYSTEM

The cooling system is functioning normally when the "Temp" lamp is out and the siren is quiet. Excessive temperature ("Temp" goes on, the siren sounds) may be due to the following: clogged water intake, defective impeller or flange in the sea-water pump, faulty thermostat or temp. gauge sender. **Look out for water penetration** during all work on the cooling system.

Check and replace impeller



The impeller can be damaged due to, e.g., shortage of water. Remove the cover on the water pump. Pull out the shaft the length required in order to screw out the impeller lock bolt. Hold against the shaft and pull off the impeller. If the impeller is damaged, fit a new one. **NOTE!** If the shaft has been removed entirely from the pump housing, check when re-fitting it that the O-ring between the sealing rings in the housing gets onto the shaft. Tighten up the impeller with the lock bolt.

If the impeller and shaft can be rotated then the flange is defective. A new flange can be fitted after the pump has been removed. Fit the cover with its gasket.

CHECK THE BELT

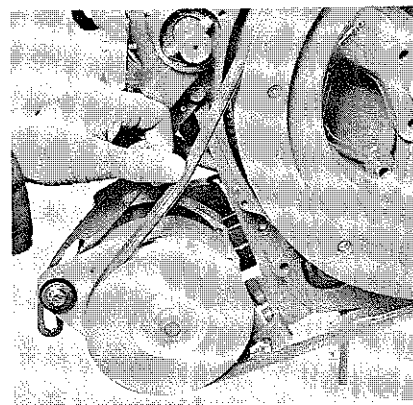

Check the belt thoroughly for wear and cracks. Replace it if there is any indication of such. To remove the belt, slacken the alternator retaining points in order to be able to slip the belt off. Wipe clean the belt groove on the pulleys before fitting the new belt. Tension the belt so that it can only be depressed 5 mm (3/16") with the thumb between the pulleys. After the engine has been run for an hour or so, re-check and if necessary adjust the belt tensioning.

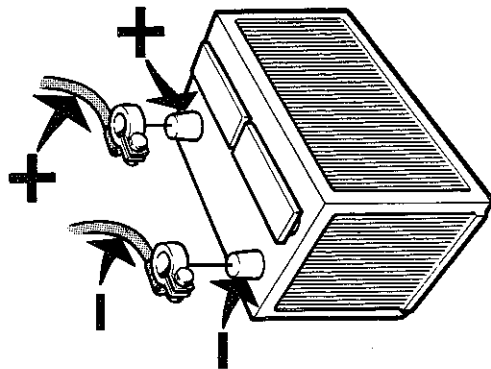

ELECTRIC SYSTEM

Alternator

The engine is equipped with an alternator. To ensure that the alternator with the built-on regulator functions without interruptions, the following important points must be observed:

1. **Never switch off the main switch until the engine has been stopped.**

To do otherwise would be to ruin the charging regulator.

2. **Do not mix up the battery connection poles.** A plus sign and a minus sign are marked on the respective poles. The minus pole is connected up to the engine body. Cable shoes should be greased and well tightened.

3. **Re-wiring between the charging circuits may not be carried out while the engine is running.**

Fit a Volvo Penta charging distributor (accessory) on the alternator when more than one battery is connected up.

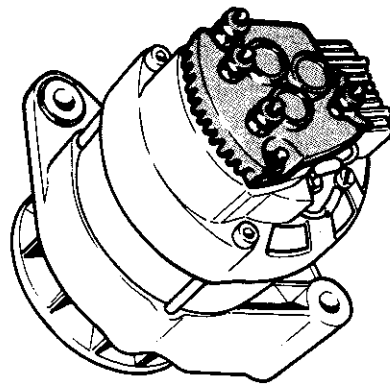

4. Observe the following in the event the engine is started with an auxiliary battery:

Let the ordinary battery remain connected up. Connect the auxiliary battery to the ordinary battery, plus to plus and minus to minus. When the engine has started, remove the auxiliary battery but **do not** break the ordinary battery's wiring circuit.

5. Do not use a rapid charging unit when the alternator is connected to the battery.
6. Before doing any work on the alternator equipment first disconnect both the battery cables.

7. In the event any electrical welding work is done on the engine or the installation components, disconnect the charging regulator cables at the alternator and insulate the cable ends.

8. Check regularly the belt tension and the cable connections.

Change fuse

A fusebox is mounted on the cylinder. A fuse breaks the electrical system when the system is overloaded. Re-connect the electrical system by transferring the cable connection to the next fuse contact.

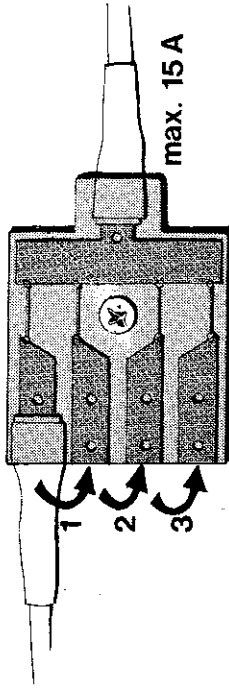

Starter motor and alternator

All work connected with the starter motor and alternator should be done by an authorized service shop. Inspection and control should be carried out in connection with a general inspection of the engine.

BATTERY

Checking the state of charge of the battery

The state of charge of the battery should be checked at least once each season. This is done by using a hydrometer which shows the specific gravity of the electrolyte, this varying with the state of charge. (See the Technical Data.)

FUEL SYSTEM

Observe the greatest cleanliness when handling the fuel system. **IMPORTANT:** Try to avoid fuel splash.

Change fuel filter

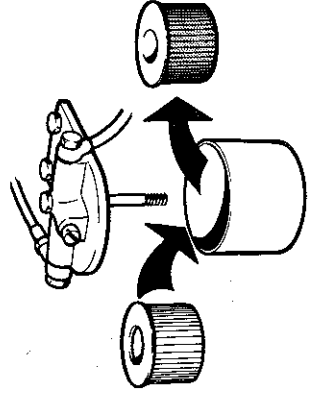

The filter element in the fuel filter should be changed at least once each season.

To do this remove the filter centre screw and lift off the filter. Clean the container and contact surfaces. Fit the new filter element and its gasket. Pump up the fuel with the hand primer. Vent the fuel system.

If the pumping effect is poor, turn over the engine a bit so that the drive cam alters its position.

Extra fuel filter

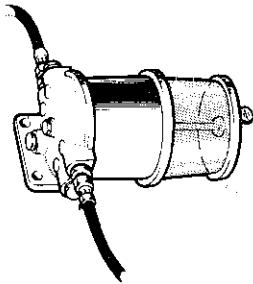

If an extra fuel filter is fitted together with a water separator, check the transparent bowl to see if there is any water in the fuel. If necessary, drain the filter via the cock in the bottom of the bowl. Try to avoid fuel splash. Pump up the fuel with the hand primer and vent the system. The fuel filter element should be changed at least once a season.

FUEL STRAINER

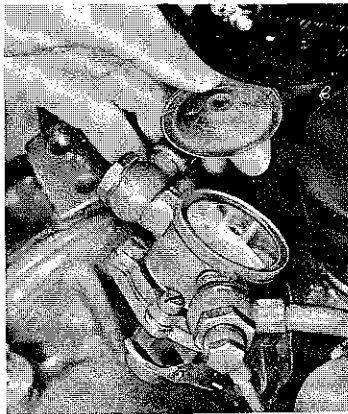

The fuel pump on the engine has a built-in strainer which is accessible after removing the cover. Clean the strainer at least once a season.

Immediately after starting the engine, check for leakage.

Always vent the fuel system. See under "Venting the fuel system".

Injector

All work on the injector of the engine must be carried out by an authorized service workshop. Check the opening pressure, spray pattern and also check for leakage every third year.

Venting the fuel system

In order for the engine to be able to start, the fuel system must be vented on the following occasions:

When changing the fine filter.

When draining through the drain hole.

When cleaning the fuel pump strainer.

After running the fuel tank empty.

When installing the fuel injection pump.

Venting is as follows:

1. Open the vent screw on the fuel filter.
2. Pump forward the fuel with the help of the hand primer until fuel free from air bubbles flows out. Close the vent screw. If the pumping effect is poor, turn over the engine a bit so that the pump drive cam alter its position.
3. If the fuel injection pump has been removed, or when starting an entirely new engine for the first time, the fuel injection pump must be vent. To do this open the vent screw on the pump. Pump with the hand primer until fuel free from air comes out. Slacken the injector delivery pipe nut and turn over the engine by means of the starter motor until fuel comes from the delivery pipe. Tighten up the delivery pipe nut and start the engine.

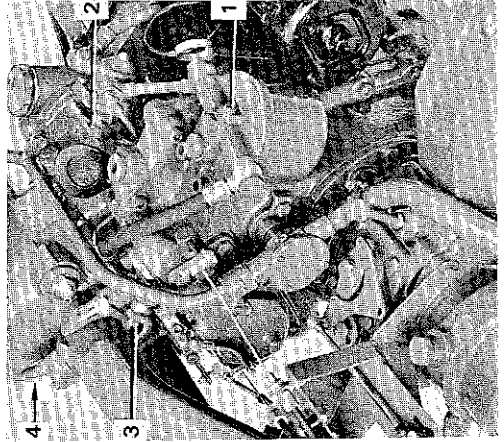

1. Vent screw, fuel filter
2. Hand primer
3. Vent screw, injection pump
4. Delivery pipe nut

LAYING-UP AND LAUNCHING

LAYING-UP AND LAUNCHING

SERVICE IN CONNECTION WITH LAYING-UP AND LAUNCHING THE BOAT

INHIBITING

IDLE ENGINE FOR BRIEF PERIODS WITH BOAT IN WATER

In order to prevent damage to the engine caused by corrosion, the engine should be run warm at least every 14 days as long as the boat is in the water. If the boat is not to be used for over a month, a long-term inhibiting should be carried out.

INHIBITING WHEN LAYING UP FOR THE WINTER

An authorized service shop should test the engine and equipment before inhibiting the engine for a long period. It is advisable to test the compression to find out the condition of the engine. If anything is not in good condition let the shop repair it already now.

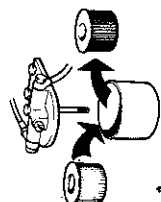
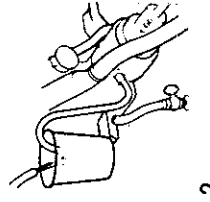

Inhibiting scheme

Carried out with boat on land

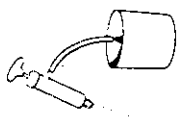
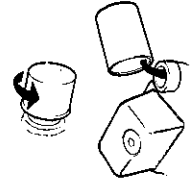
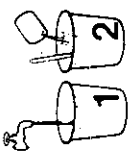
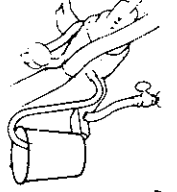

 <p>1</p>	<p>Change the fuel filter. Pump fuel forward and vent the system. See "Venting the fuel system" (page 19). Check the fuel hoses as well as the complete fuel system for leakages. If an extra fuel filter is fitted, this filter cartridge must also be changed.</p>
 <p>2</p>	<p>Drain the cooling water from engine and reverse gear (pos 7 and 9 pages 28 - 29). Disconnect the reverse gear suction line from the reverse gear. Connect a hose with an inner diameter of 1/2" and insert the free hose end into a container with fresh water. Arrange to have water added to the container.</p>

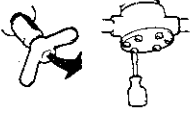
 <p>3</p>	<p>Run the engine at idle for about 5-10 minutes, so that it is flushed throughout with fresh water. Check that nothing is plashed near the exhaust outlet. Drain all water from the engine and reverse gear. Then close all drain points. NOTE! Let not the propeller rotate.</p>
 <p>4</p>	<p>Pump out all oil from the engine. (On reverse- and reduction gear, the oil in this must be changed each 200 hours of operation.) Use the oil drainage pump.</p>
 <p>5</p>	<p>Change the oil filter. Fill up the engine and reverse- and reduction gear to the correct level with Volvo Penta diesel engine oil, which also has corrosion protective properties. After this the engine is ready to run on this oil next season. By long-time inhibiting, exceeding a normal winter laying-up, preservative oil must be used. This should be of the type Esso Rustban 623, Shell Ensis Oil or corresponding oil. In this case the oil filter shall not be replaced until launching.</p>
 <p>6</p>	<p>Mix a 20 % rust-proofing mixture containing fresh-water and emulsifying, rust-proofing oil. NOTE! Water first, than oil. Use, e.g. Esso Cutwell 40, Shell Donax C or similar. As an alternative, a freeze-resistant 30% glycol mixture can be used.</p>
 <p>7</p>	<p>Insert the hose into the rust-proofing mixture. Start the engine and let it run idle until the mixture is finished. NOTE! The pump must not be allowed to run dry.</p>

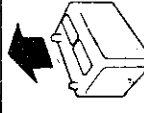

LAYING-UP AND LAUNCHING

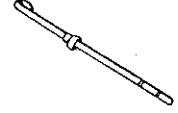
 <p>8</p>	<p>The rust-proofing mixture does not have anti-freezing properties, therefore it has to be drained off the engine and reverse gear. (28-29). Check that the water drains off, since dirt can block the cocks. Then close all cocks. Remove the cover from the seawater-pump. Check that the impeller is undamaged. Refit the cover. If it's difficult to reach the water drain plug on the gear it can be fitted up with Volvo Original Ethylene glycol.</p> <p>NOTE! Do not remove the impeller if undamaged. Reconnect hoses which have been removed.</p>
 <p>9</p>	<p>Clean the outside of engine and reverse gear. Touch-in any bare patches in the paintwork with the original type of paint. Spray the components of the electrical system, and all the control components with anti-moisture spray.</p> <p>Maintenance of folding propeller, see page 35.</p>
 <p>10</p>	<p>Remove the battery. For proper maintenance it needs to be charged to prevent it from being damaged.</p>

SERVICE IN CONNECTION WITH LAUNCHING

 <p>11</p>	<p>If Volvo Penta diesel engine oil has been used, you only need to check the oil level in the engine and reverse gear.</p> <p>If preservative oil has been used, both the oil and the filter must be replaced. See under "Service after every 50 hours of operation".</p>
 <p>12</p>	<p>Check the tightening of all hose-clamps. Check that all drain-cocks are closed. Clean the engine and drive on the outside. Check the exhaust-hose.</p> <p>Prevent marine growth by painting the bottom of the boat with anti-fouling paint.</p> <p>Vent the fuel system (see page 19).</p> <p>Maintenance of folding propeller, see page 35.</p>

LAYING-UP LAUNCHING

 <p>13</p>	<p>Install the battery or batteries, which should have been fully charged. Grease the cable shoes. Fit the battery cables. Important! Do not mix the polarity. Tighten the cable shoes well. Launch the boat.</p>
 <p>14</p>	<p>Start the engine. See instructions on page 5. Run the engine warm with gear engaged, if this is possible. Check and make sure there is no fuel leakage, no water leakage or exhaust gas leakage. Check further that the manoeuvring functions are in order.</p>
 <p>15</p>	<p>When necessary, contact an authorized Volvo-Penta service workshop. Let them service your engine and drive or reverse gear according to the instructions given in the servicing scheme, and if possible, do it very long time before launching because the shop can be occupied if you want to have the service carried out just before launching.</p>

NOTES

.....

.....

.....

.....

.....

.....

.....

.....

.....

.....

FAULT TRACING SCHEME

TRACING FAULTS WITH INTERRUPTIONS IN OPERATION

The fault tracing scheme given below lists only the most usual reasons for faults that give rise to interruptions in operation. With the help of the instructions given in this handbook, the owner can generally remedy most of the reasons for the faults listed below. When in doubt always contact the nearest Volvo Penta service shop.

Engine does not start	Engine stops	Engine does not reach correct operating speed at full throttle	Engine runs unevenly or vibrates abnormally	Engine becomes abnormally hot	Reason	See
x					Main switch not switched on; flat battery, breakage in electric cables or blown fuse.	pp 5, 12, 16 17, 27
x	x				Empty fuel tank, closed fuel cock, blocked fuel filter.	pp 17, 18
x	x		x		Water, air or impurities in fuel.	pp 17, 18, 19
x	x	x	x		Defective injector.	pp 18, 26
	x		x		Idling speed not properly adjusted.	p 25
		x			Boat overloaded.	
		x			Marine growth on boat bottom.	
			x		Damaged propeller.	
				x	Blockage in cooling water intake, cooling jackets, defective impeller or thermostat.	p 15

TECHNICAL DATA

Technical Data

General

Engine designation MD5A
 Operation with direct injection 4-stroke diesel

Number of cylinders 1
 Propeller shaft output¹⁾ kW (h.p.) at 41.7 rev/sec (2500 rev/min) 5.5 (7.5)
 Max. operating speed rev/sec (rev/min) 41.7 (2500)
 Bore, mm (in) 84 (3.307)
 Stroke, mm (in) 80 (3.150)
 Displacement, dm³ (in³) 0.443 (27)
 Compr. pressure, MPa (kp/cm² = lbf/in²) 200-220
 (120-22 = 284-313)
 Idling speed, rev/sec (rev/min) approx 12 (700)
 Direction of rotation looking at flywheel Clockwise
 Engine inclination underway:
 Rearwards, max. 15°
 To the sides, max. 20°
 Engine weight, incl. reverse gear, kg (lb.) 111 (244)

Valves

Valve clearance, hot engine
 Inlet, mm (in) 0.30 (0.0012)
 Exhaust, mm (in.) 0.35 (0.0014)

Reverse gear

Type designation MSB
 Reduction ratio "Forward" and "Reverse" 1.91:1

Lubricating system

Engine
 Oil capacity, engine, litres (Imp.qts. = US qts.), excl. filter 2.0 (1.80 = 2.10)
 incl. filter 2.1 (1.85 = 2.20)
 Oil quality Diesel lubricating oil Service CD (DS)

Viscosity:

above +10°C (140°F) SAE 20W/30²⁾
 below +10°C (140°F) SAE 10W 3)
 Oil pressure, hot engine, idling speed, MPa (kp/cm² = lbf/in²) 15-25 (1.5-2.5 = 21-35)
 at full speed, MPa (kp/cm² = lbf/in²) 40-50 (4.0-5.0 = 57-71)

- 1) Propeller shaft output acc. to DIN Leistung B für Dauerbetrieb.
- 2) Volvo Penta CD Double Grad oil.
- 3) Volvo Penta CD Single Grade oil.

TECHNICAL DATA

Reverse gear

Oil quality/Viscosity
Oil capacity, litre (qt.)

See under "Engine"
0.55 (0.5)

Cooling system

Thermostat, starts opening at °C (°F)
tully open at °C (°F)

60°±2 (140±2)
90° (195)

Fuel system

Fuel injection pump, make

Bosch

Feed pressure MPa (kp/cm² = lbf/in²)

7.5 (0.75 = 11)

Injector, make

Bosch

opening pressure MPa (kp/cm² = lbf/in²)

1800 (180 = 2560)

Pre-injection angle, crankshaft degrees B.T.D.C.

Fuel quality "Autodiesel"

25-28°
Cet. rating minimum 45

Electrical system

Battery voltage

12V

Battery capacity, standard

60 Ah

max.

120 Ah

Starter motor

0.8 kW (1.1 h.p.)

Alternator

35A (420W)

Battery electrolyte specific gravity:

Charging carried out at g/cm³

1.230

Fully charged battery, g/cm³

1.275-1.285

Tightening torques

Cylinder head nuts, Nm (kpm = lb.ftf)

70 (7.0 = 50)

Connecting rod bolts, Nm (kpm = lb.ftf)

70 (7.0 = 50)

Crankshaft main bearings, Nm (kpm = lb.ftf)

70 (7.0 = 50)

Flywheel nut, Nm (kpm = lb.ftf)

500 (50.0 = 362)

Injector nuts, Nm (kpm = lb.ftf)

10 (1.0 = 7)

WIRING DIAGRAM

Cable colour code

Marking	Colour	mm ²	A.W.G.
A	White	6	9
B	Black	1.5	15
B'	Black	0.6	19
B''	Black	0.75	18
C	Red	6	9
C'	Red	35	1
C''	Red	0.6	19
F	Yellow	1.5	15
G	Brown	1.5	15
H'	Blue	35	1
I	Green/Red	1.5	15
I'	Green/Red	0.75	18
J	Green	1.5	15
J''	Green	0.6	19
J'''	Green	0.75	18
K	Blue/Yellow	0.75	18
L	White/Red	0.75	18
M	Blue/Red	0.75	18

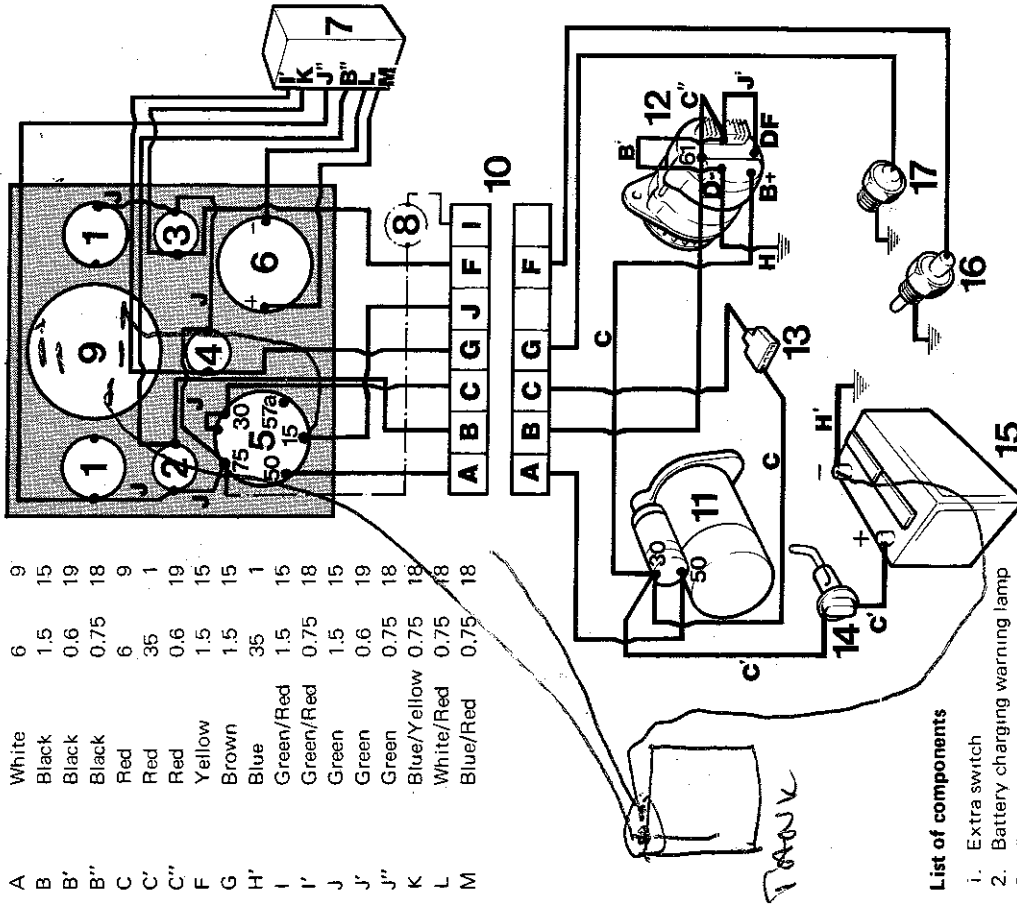

List of components

1. Extra switch
2. Battery charging warning lamp
3. Excessive temp. warning lamp
4. Low oil pressure warning lamp
5. Key switch
6. Siren
7. Alarm unit
8. Battery charging warning lamp (for battery circuit, opt. equipm.)
9. Place for instruments, op. equipm.
10. Rapid connector
11. Starter motor
12. Alternator
13. Fusebox
14. Main switch
15. Battery
16. Temperature sender
17. Oil pressure sender

ENGINE COMPONENT GUIDE

MD5A

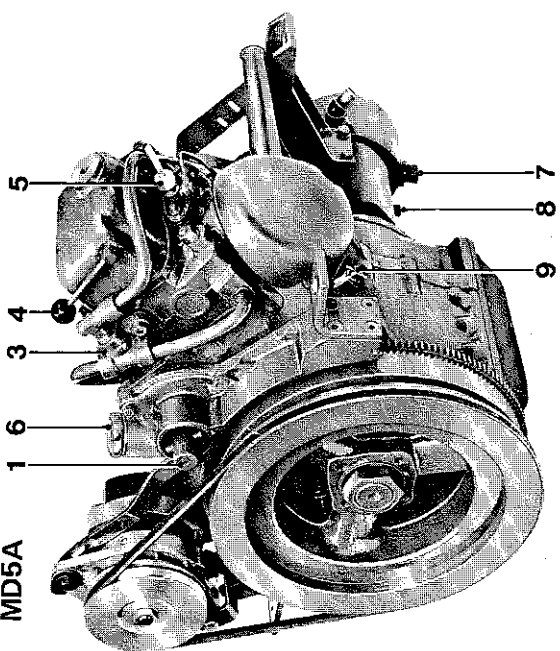

1. Connection for manual starting crank
2. Fusebox
3. Thermostat housing
4. Decompression handle
5. Injector
6. Oil filler cap, engine
7. Reverse gear water drainage
8. Reverse gear oil drainage
9. Engine water drainage

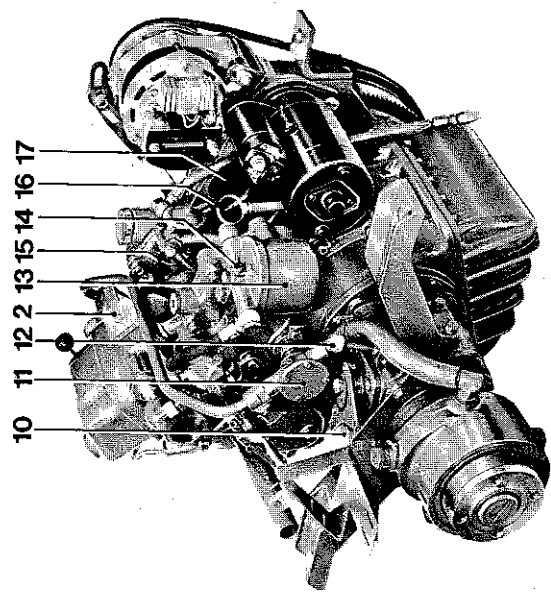

10. Reverse gear oil filler
11. Cooling water pump
12. Reverse gear oil dipstick
13. Fuel filter
14. Vent screw
15. Fuel hand primer
16. Engine oil dipstick
17. Oil filter

ENGINE COMPONENT GUIDE

MD5A/110S

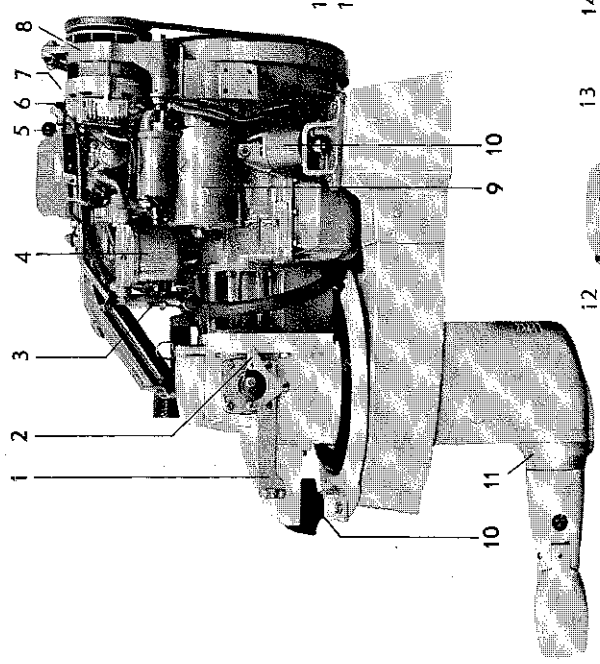

1. Bracket for control cable
2. Arm for gear change
3. Sea water pump
4. Fuel filter
5. Decompression lever. Engine not equipped with hand start
6. Fuel pump.
7. Oil filter for engine
8. Alternator
9. Starter motor
10. Rubber engine suspension
11. Zinc anode

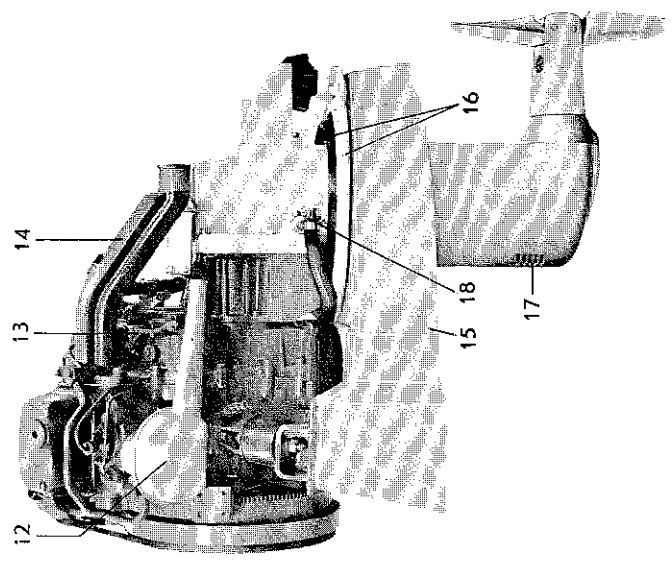

12. Air intake silencer with filter
13. Speed control arm
14. Water cooled exhaust elbow
15. Engine bed
16. Seal between bed and drive
17. Cooling water intake
18. Cock for cooling water

TECHNICAL DESCRIPTION

S-drive 110S

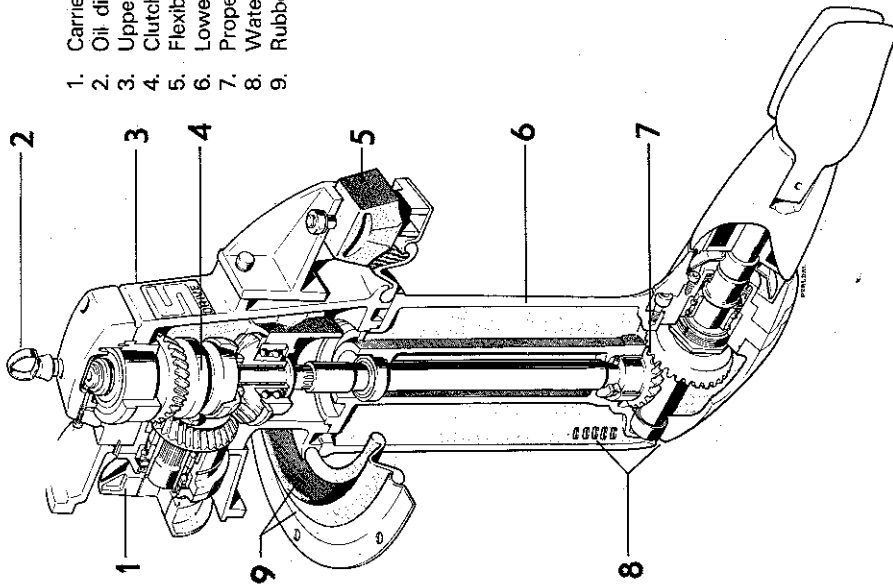

1. Carrier with rubber element
2. Oil dipstick
3. Upper gear housing
4. Clutch cone, type Silent Shift
5. Flexible suspension
6. Lower gear housing
7. Propeller shaft gear with helical bevel gears
8. Water intake for engine cooling system
9. Rubber membrane between drive and hull

MD5A/110S

The following supplementary instructions cover the description and maintenance of the S-drive 110S, also the equipment components and data which differ between the reverse gear equipped engine and the engine equipped with the sailboat drive. For maintenance and description of the engine, the previous information should be followed.

CHECKS AND SERVICE

OIL LEVEL IN DRIVE

Check every 14 days that the oil level is within the dipstick's markings.

The oil dipstick has a baionet fitting, therefore it must be turned when lifting and replacing. Note the sealing ring on the dipstick. When checking the oil level the dipstick must be turned to the locked position.

Oil filling is done through the hole for the dipstick. **NOTE:** Do not overfill. Regarding choice of oil, refer to "Technical Data" page 32.

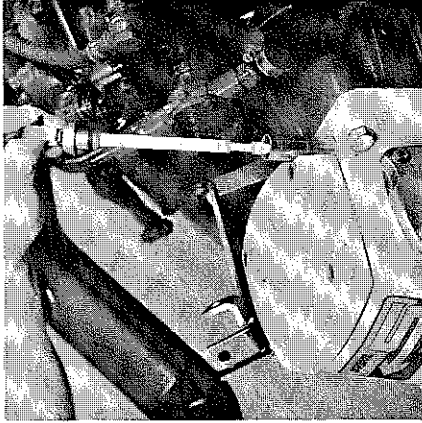

CHANGING DRIVES OIL

Remove the oil dipstick. Unscrew the drain plug under the propeller gear housing and let the oil drain off. Refit the drain plug together with O-ring. Fill with oil through the dipstick's hole. **NOTE:** Do not overfill. Regarding choice of oil, refer to "Technical Data" page 32.

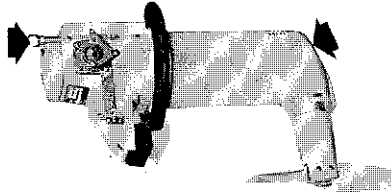

ZINC ANODE

Change the zinc anode if it has corroded by more than 50 %. Remove the propeller and spacer ring together with the deflector and remove the two allen screws holding the zinc anode. Scrape the contact surface of the drive and fit a new zinc anode. Make sure that there is a good metallic contact between the zinc anode and the drive. **NOTE:** The zinc anode must not be painted. Check that the propeller blade runs easily (folding propeller) and lubricate the joints. Apply Molykote or similar in the hub and on the axle. The propeller should not be mounted on the boat when it is laid up for the winter. Protect the axle.

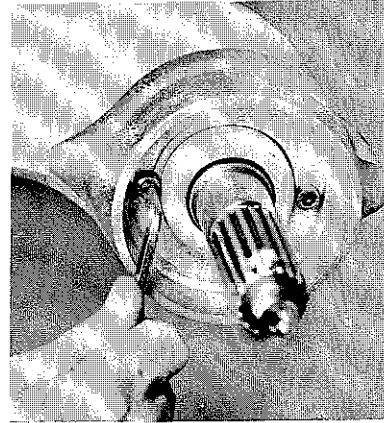

CHECKS AND SERVICE

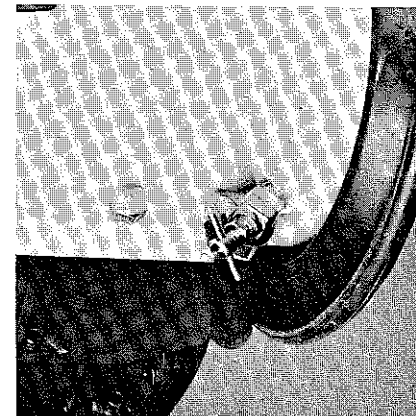

COOLING SYSTEM

The cooling water intake for the engine's cooling is located in the drives' lower gear housing. Check, when the boat is taken up on land, that the grill and the round hole on the front of the drive is free from marine growth. If there is a danger of freezing and when inhibiting, the cooling water is drained from the drive and the pump by the cock on the drive. **NOTE. When draining while the boat is still afloat, the cock must be closed first.** Do not forget to open the cock when restarting engine. When laying up for the winter the vacuum valve should be removed from the system, disassembled and the salt deposits cleaned off.

GENERAL MAINTENANCE

When the boat is ashore, check the paintwork on the drive and, if necessary, touch up with genuine Volvo Penta paint. Paint the drive with anti-fouling paint which does not contain copper. If the rubber membrane is removed the space between the rubber seal and the rubber membrane should also be painted. Check from the outside that the rubber membrane at the bottom through-hull aperture of the drive is in place and from the inside that the rubber seal between the bed and the drive feels elastic and has not been subjected to mechanical damage.

The rubber seals should be changed every 5 years.

RUNNING

Important

When changing from engine power to sailing, the propeller's rotation is stopped by engaging reverse. During sailing the control should be in either the neutral or reverse position if a folding-propeller is used. If a fixed propeller is used then the control must be in the neutral position.

TECHNICAL DATA

Type designation	MD5A/110S
Sailboat drive, type	110S
Ratio	1.66:1
Oil capacity, dm ³ (Imp qts, Us qts.)	1.8 (1.6, 1.9)
Oil quality	Diesel, lube oil CD
Viscosity	SAE20W/30 ¹⁾
Total weight, engine and sailboat drive kg (lbs)	128 (281)

¹⁾ Volvo Penta CD oil, Double grade.

ON BOARD DATA

LOA = m (ft.), Beam = m (ft.), Draught = m
 (ft.), Displacement = Fuel tank cap. = l
 (Imp.gals. = US gals.), Water tank = l
 (Imp.gals. = US gals.), Battery cap., std. circuits = Ah.
 Battery cap., opt. equipment circuit = Ah.

The light bulbs have the following wattage:

Instruments: W. Cabin: W. Pentry: W. Toilet:
 let: W. Compass: W. Ports./Starboard lights: W.
 Stern lights: W. Masthead lights: W. Searchlight: W.
 Cockpit: W.

The tool kit and the spare parts kit contain the following:

CHECKS AND SERVICE HAVE BEEN CARRIED OUT AS FOLLOWS:

50 hour intervals

dat ___ / ___ - by ___ dat ___ / ___ - by ___
 dat ___ / ___ - by ___ dat ___ / ___ - by ___
 dat ___ / ___ - by ___ dat ___ / ___ - by ___
 dat ___ / ___ - by ___ dat ___ / ___ - by ___
 dat ___ / ___ - by ___ dat ___ / ___ - by ___

100 hour intervals

dat ___ / ___ - by ___ dat ___ / ___ - by ___
 dat ___ / ___ - by ___ dat ___ / ___ - by ___
 dat ___ / ___ - by ___ dat ___ / ___ - by ___
 dat ___ / ___ - by ___ dat ___ / ___ - by ___

200 hour intervals

dat ___ / ___ - by ___ dat ___ / ___ - by ___
 dat ___ / ___ - by ___ dat ___ / ___ - by ___
 dat ___ / ___ - by ___ dat ___ / ___ - by ___
 dat ___ / ___ - by ___ dat ___ / ___ - by ___

INDEX

Alternator	7, 14, 16, 27	Lubricating oil	3, 25
Battery	12	Main switch	5, 6
Belt tensioning	12, 14,	Oil change	12, 13
Charging regulator	7, 16	Oil dipstick, engine	28
Controls	2, 6	Oil dipstick, reverse gear	28
Cooling system	8	Oil filter	14, 20, 28
Cylinder head bolts	15	Oil lever check	11
De-inhibiting	22	Preparations before starting	4
Drain cocks	28	Running	6
Electrical system	16	Safety equipment	4
Engine assembly	7	Sea-water pump	8, 15, 28
Fault tracing scheme	24	Sailboat drive 110S	30, 31, 32
Folding propeller	6, 35	Starter motor	17
Fuel	3	Starting	5
Fuel filters	17	Technical Data	25, 26
Fuel pump	8	Thermostat	8, 26
Fusebox	7, 17	Valve clearances	13, 25
Hand primer	8, 17, 23, 28	Venting the fuel system	19
Hand starter	5, 28	Wiring diagrams	27
Impeller	15		
Inhibiting	20		
Injector	18, 23		
Instruments	2, 27		

FOLDING PROPELLER

if the boat is supplied with a folding propeller it is important to know about and observe the following:

Putting in "FORWARD" should take place during idling. Changing at higher r.p.m. can damage the propeller because of the great stress resulting when the blades are folded out.

When the boat is to be laid up the propeller should be treated as follows:

Clean the propeller with fresh water, remove the screws for the propeller blades' suspension pins, take away the pins and the blades. Clean all surfaces and then lubricate all the propeller parts with grease. Take special care with the bearing surfaces on pins and blades. Protect the propeller boss.

When launching:

Fit the propeller together, wipe off superfluous grease and check that the blades fold inwards and outwards easily.

NOTES

-
-
-
-
-
-
-
-
-
-
-
-
-
-
-
-

Notes

Personal information

Name
Address
Phone

Nearest Volvo Penta dealer

Name
Address
Phone

Technical information

Engine type
Serial number, engine
Reverse gear type Ratio
Reverse gear, or S-drive, serial no
Propeller size

.....
.....
.....
.....
.....
.....
.....
.....
.....
.....
.....
.....
.....
.....
.....
.....
.....
.....
.....
.....
.....