

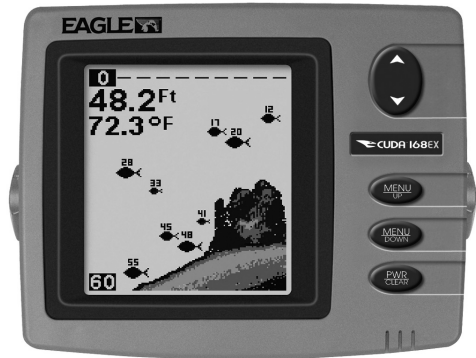

www.eaglesonar.com

Pub. 988-0143-631



Cuda™ 128, Cuda™ 128 Portable, Cuda™ 168, Cuda™ 168EX Fish-finding & Depth Sounding Sonars Installation and Operation Instructions

Copyright © 2002 Eagle Electronics
All rights reserved.

Eagle® is a registered trademark of Eagle Electronics
Marine-Tex™ is a trademark of Illinois Tool Works Inc.

Eagle Electronics may find it necessary to change or end our policies, regulations, and special offers at any time. We reserve the right to do so without notice. All features and specifications subject to change without notice. All screens in this manual are simulated.

**For free owner's manuals and other information,
visit our web site:
www.eaglesonar.com**

Eagle Electronics
P.O. Box 669
Catoosa, OK USA 74015
Printed in USA.

Table of Contents

Introduction	1
Capabilities and Specifications: Cuda™ Family	1
Installation Preparations	3
Transducer Installation	4
Recommended Tools and Supplies	4
Selecting a Transducer Location	5
Shoot-Thru-Hull vs. Transom Mounting	7
Transom Transducer Assembly and Mounting	7
Trolling Motor Bracket Installation.....	12
Transducer Orientation and Fish Arches	12
Shoot-Thru-Hull Preparation and Installation	14
Power and Cable Connections.....	16
Mounting the Sonar Unit: In-Dash or Bracket	18
In-Dash Installation	18
Bracket Installation	21
Portable Sonar Installation.....	25
Operation	30
Keyboard Basics.....	30
PWR/Clear (Power and Clear).....	30
Menu Up and Menu Down	30
Up and Down Arrows.....	31
Memory.....	31
Menus	31
Display – Opening Screen	32
Chart Scroll (Stopping and Starting).....	33
Full Chart.....	34
Depth Range Zoom (Automatic and Manual).....	35
Zoom	36
Sensitivity	37
Grayline®	40
Fish I.D.™	41

FishTrack™	43
Chart Scroll Speed	44
Noise Reject and ASP™ (Advanced Signal Processing)	44
Alarms	45
Fish Alarm.....	45
Depth Alarms	46
Shallow Alarm.....	46
Deep Alarm	46
Display Adjustments	47
Backlights.....	47
Display Contrast	47
Depth Units of Measure	48
Preset Unit (Reset All Options).....	48
System Info	48
Simulator.....	48
Digital Data Size for Depth and Temperature	49
Troubleshooting	50
Warranty and Service Information	57

Introduction

Thank you for buying an Eagle® sonar! Your unit is a high-quality sonar designed for both professional and novice fishermen. All Eagle sonars have an automatic mode that finds and displays the bottom, fish, underwater structure and more – right out of the box. All you have to do is press the on (**PWR**) key.

However, if you want to fine-tune your unit, press the **MENU UP** key. The sonar has several powerful features you can control by scrolling through easy-to-use menus with the arrow and menu keys.

To get started with your Eagle sonar, first read the installation section. It contains instructions for mounting the sonar unit and the transducer.

Following recommended installation practices will pay off in optimum performance of your Eagle sonar. Improper installation can cause problems down the road, especially if the transducer is badly mounted.

After you've read the installation instructions, install the unit and accessories. Then, read the rest of the manual. The more you know about your sonar, the better it will work for you.

Take advantage of the Simulator feature. It allows you to practice operating your sonar before you get it in the water. And when you finally head for your favorite fishing hole, take this manual along for reference.

Capabilities and Specifications: Cuda™ Family

General

Case size: **Cuda 128 and Cuda 168:** 5.8" H x 4.3" W x 2.5" D (14.7 cm H x 10.8 cm W x 6.6 cm D).

Cuda 168EX: 5.4" H x 6.9" W x 3.4" D (13.8 cm H x 17.6 cm W x 8.6 cm D).

Sealed, waterproof; suitable for saltwater use.

Display:..... High-contrast Film SuperTwist LCD.

Diagonal viewing area:

Cuda 128 and Cuda 168: 4.0" (10.2 cm).

Cuda 168EX: 4.5" (11.4 cm).

- Resolution:**..... **Cuda 128 and Cuda 128 Portable:**
 128 pixels (vert.) x 65 pixels (horiz.)
 resolution; 8,320 total pixels.
- Cuda 168 and Cuda 168 EX:**
 168 pixels (vert.) x 132 pixels (horiz.)
 resolution; 22,176 total pixels.
- Backlighting:**..... Backlit screen and keypad for night use.
- Input power:**..... 10 to 17 volts DC.
- Current drain:** 110 ma lights off; 250 ma lights on.
- Back-up memory:** Built-in memory stores sonar settings when unit is turned off.

Sonar

- Frequency:**..... 200 kHz.
- Transducers:** A Skimmer[®] transducer comes packed with your sonar unit. Its 20° cone angle offers a wide fish detection area of up to 60° with high sensitivity settings. Operates at boat speeds up to 70 mph (61 kts).
- Transmitter:** 800 watts peak-to-peak; 100 watts RMS.
- Sonar sounding depth capability:** 600 feet (180 meters). Actual capability depends on transducer configuration and installation, bottom composition and water conditions. All sonar units typically read deeper in fresh water than in salt water.
- Depth display:**..... Continuous digital readout.
- Audible alarms:** Deep/shallow/fish.
- Automatic ranging:**..... Yes.
- Auto bottom track:**..... Yes.
- Zoom bottom track:** Yes.
- Surface water temp:**..... Yes.

NOTICE!

The storage and operation temperature range for your unit is from -4 degrees to +167 degrees Fahrenheit (-20 degrees to +75 degrees Celsius). Extended storage or operation in temperatures higher or lower than specified will damage the liquid crystal display in your unit. This type of damage is not covered by the warranty. For more information, contact the factory's Customer Service Department; phone numbers are inside the manual's back cover.

Installation Preparations

You can install the sonar system in some other order if you prefer, but we recommend this installation sequence:

Caution:

You should read over this entire installation section before drilling any holes in your vessel!

1. Determine the approximate location for the sonar unit, so you can plan how and where to route the cables for the transducer and power. This will help you make sure you have enough cable length for the desired configuration.
2. Determine the approximate location for the transducer and its cable route.
3. Determine the location of your battery or other power connection, along with the power cable route.
4. Install the transducer and route the transducer cable to the sonar unit.
5. Install the power cable and route it to the sonar unit.
6. Mount the sonar unit.

Transducer Installation

These instructions will help you install your Skimmer® transducer on a transom, on a trolling motor or inside a hull. Please read all instructions before proceeding with any installation.

Your Skimmer transducer typically comes packaged with a one-piece stainless steel bracket for mounting it to the transom of your boat. The optional trolling motor mount uses a one-piece plastic bracket with an adjustable strap. These are "kick-up" mounting brackets. They help prevent damage if the transducer strikes an object while the boat is moving. If the transducer does "kick-up," the bracket can easily be pushed back into place without tools.

Read these instructions carefully *before* attempting the installation. Determine which of the installation methods is right for your boat. ***Remember, the transducer installation is the most critical part of a sonar installation.***

Recommended Tools and supplies

If you prefer the option of routing the cable through the transom, you will need a 5/8" drill bit. The following installation types also call for these recommended tools and required supplies (supplies are *not* included):

Transom installation

Tools include: two adjustable wrenches, drill, #29 (0.136") drill bit, flat-head screwdriver. Supplies: *high quality, marine grade* above- or below-waterline caulking compound.

Trolling motor installations

Tools: two adjustable wrenches, flat-head screwdriver. Supplies: plastic cable ties.

Shoot-through hull installations

Tools: these will vary depending on your hull's composition. Consult your boat dealer or manufacturer. Supplies: 100 grit sandpaper, good quality epoxy adhesive.

Selecting a Transducer Location

1. The transducer must be placed in a location that has a smooth flow of water at all times. If the transducer is to be mounted inside the hull, then the chosen location must be in the water at all times. If the transducer is not placed in a smooth flow of water, interference caused by bubbles and turbulence will show on the sonar's display in the form of random lines or dots whenever the boat is moving.

NOTE:

Some aluminum boats with strakes or ribs on the outside of the hull create large amounts of turbulence at high speed. These boats typically have large outboard motors capable of propelling the boat at speeds faster than 35 mph. Typically, a good location on aluminum boats is between the ribs closest to the engine.

2. The transducer should be installed with its face pointing straight down, if possible.
3. If the transducer is mounted on the transom, make sure it doesn't interfere with the trailer or hauling of the boat. Also, don't mount it closer than approximately one foot from the engine's lower unit. This will prevent cavitation (bubble) interference with propeller operation.
4. If possible, route the transducer cable away from other wiring on the boat. Electrical noise from engine wiring, bilge pumps and aerators can be displayed on the sonar's screen. Use caution when routing the transducer cable around these wires.

CAUTION: Clamp the transducer cable to transom near the transducer. This will help prevent the transducer from entering the boat if it is knocked off at high speed.

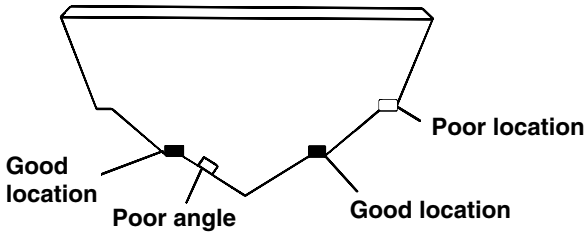
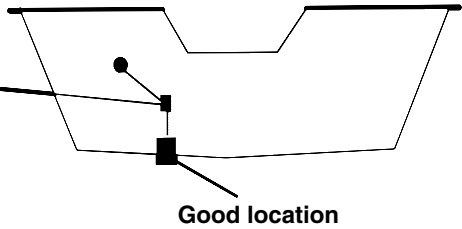

Good and poor transducer locations.

How low should you go?

For most situations, you should install your Skimmer transducer so that its centerline is level with the bottom of the boat hull. This will usually give you the best combination of smooth water flow and protection from bangs and bumps.

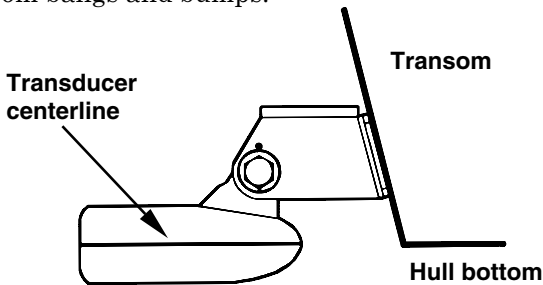

Align transducer centerline with hull bottom.

However, there are times when you may need to adjust the transducer slightly higher or lower. (The slots in the mounting brackets allow you

to loosen the screws and slide the transducer up or down.) If you frequently lose bottom signal lock while running at high speed, the transducer may be coming out of the water as you cross waves or wakes. Move the transducer a little lower to help prevent this.

If you cruise or fish around lots of structure and cover, your transducer may be frequently kicking up from object strikes. If you wish, you may move the transducer a little higher for more protection.

There are two extremes you should avoid. Never let the edge of the mounting bracket extend below the bottom of the hull. Never let the bottom – the face – of the transducer rise above the bottom of the hull.

Shoot-thru-hull vs. Transom Mounting

Typically, shoot-thru-hull installations give excellent high speed operation and good to excellent depth capability. There is no possibility of damage from floating objects. It can't be knocked off when docking or loading on the trailer.

However, the shoot-thru-hull installation does have its drawbacks. First, some loss of sensitivity does occur, even on the best hulls. This varies from hull to hull, even from different installations on the same hull. This is caused by differences in hull lay-up and construction.

Second, the transducer angle cannot be adjusted for the best fish arches. This can be a problem on some hulls that sit with the bow high when at rest or at slow trolling speeds. Follow the procedure listed in the shoot-thru-hull installation section at the end of this lesson to determine if you can satisfactorily shoot through the hull.

TRANSOM TRANSDUCER ASSEMBLY AND MOUNTING

The best way to install the transducer is to loosely assemble all of the parts first, place the transducer's bracket against the transom and see if you can move the transducer so that it's parallel with the ground.

1. Assembling the bracket. Press the two small plastic ratchets into the sides of the metal bracket as shown in the following illustration. Notice

there are letters molded into each ratchet. Place each ratchet into the bracket with the letter "A" aligned with the dot stamped into the metal bracket. This position sets the transducer's coarse angle adjustment for a 14° transom. Most outboard and stern-drive transoms have a 14° angle.



Align plastic ratchets in bracket.

2. Aligning the transducer on the transom. Slide the transducer between the two ratchets. Temporarily slide the bolt through the transducer assembly and hold it against the transom. Looking at the transducer from the side, check to see if it will adjust so that its face is parallel to the ground. If it does, then the "A" position is correct for your hull.

If the transducer's face isn't parallel with the ground, remove the transducer and ratchets from the bracket. Place the ratchets into the holes in the bracket with the letter "B" aligned with the dot stamped in the bracket.

Reassemble the transducer and bracket and place them against the transom. Again, check to see if you can move the transducer so it's parallel with the ground. If you can, then go to step 3. If it doesn't, repeat step 2, but use a different alignment letter until you can place the transducer on the transom correctly.

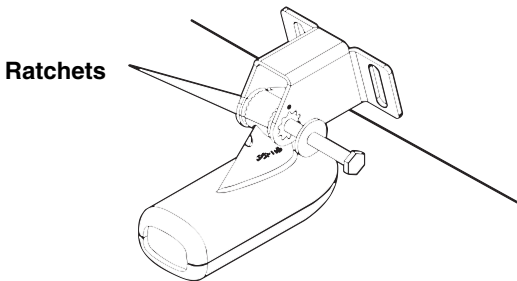

Insert bolt and check transducer position on transom.

- 3. Assembling the transducer.** Once you determine the correct position for the ratchets, assemble the transducer as shown in the following figure. Don't tighten the lock nut at this time.

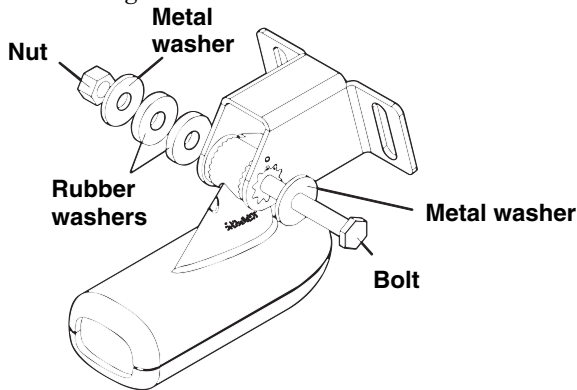

Assemble transducer and bracket.

- 4. Drilling mounting holes.** Hold the transducer and bracket assembly against the transom. The transducer should be roughly parallel to the ground. The transducer's centerline should be in line with the bottom of the hull. Don't let the bracket extend below the hull!

Mark the center of each slot for the mounting screw pilot holes. You will drill one hole in the center of each slot.

Drill the holes using the #29 bit (for the #10 screws).

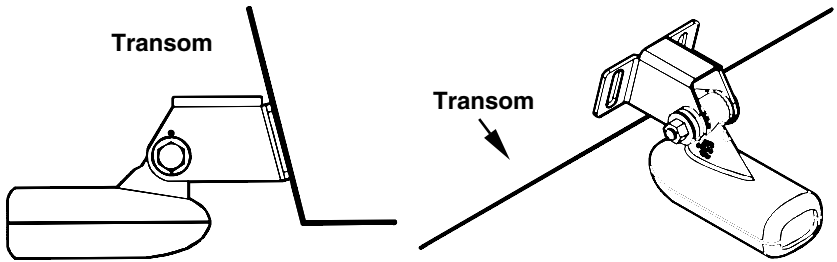

Position transducer mount on transom and mark mounting holes.
Side view shown at left and seen from above at right.

5. **Attaching transducer to transom.** Remove the transducer from the bracket and re-assemble it with the cable passing through the bracket over the bolt as shown in the following figures.

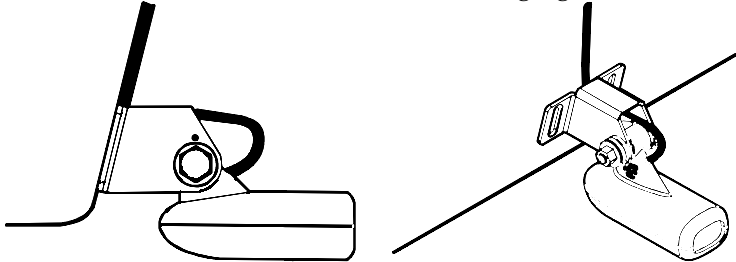

Route cable over bolt and through bracket. Side view shown at left and seen from above at right.

Attach the transducer to the transom. Slide the transducer up or down until it's aligned properly with the bottom of the hull as shown in the preceding and following figures. Tighten the bracket's mounting screws, sealing them with the caulking compound.

Adjust the transducer so that it's parallel to the ground and tighten the nut until it touches the outer washer, then add 1/4 turn. *Don't over tighten the lock nut!* If you do, the transducer won't "kick-up" if it strikes an object in the water.

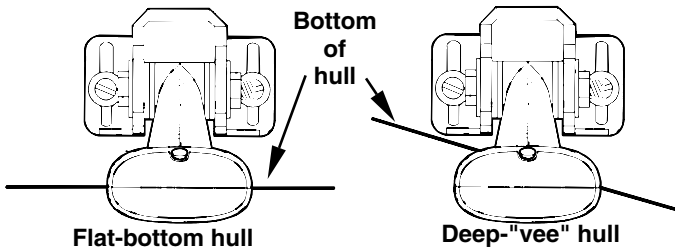

Align transducer centerline with hull bottom and attach to transom.

- 6. Route the transducer cable through or over the transom to the sonar unit.** Make sure to leave some slack in the cable at the transducer. If possible, route the transducer cable away from other wiring on the boat. Electrical noise from the engine's wiring, bilge pumps, VHF radio wires and cables, and aerators can be picked up by the sonar. Use caution when routing the transducer cable around these wires.

WARNING:

Clamp the transducer cable to the transom close to the transducer. This can prevent the transducer from entering the boat if it is knocked off at high speed.

If you need to drill a hole in the transom to pass the connector through, the required hole size is 5/8".

Caution:

If you drill a hole in the transom for the cable, make sure it is located above the waterline. After installation, be sure to seal the hole with the same marine grade above- or below-waterline sealant used for the mounting screws.

- 7. Make a test run to determine the results.** If the bottom is lost at high speed, or if noise appears on the display, try sliding the transducer bracket down. This puts the transducer deeper into the water, hopefully below the turbulence causing the noise. Don't allow the transducer bracket to go below the bottom of the hull!

TROLLING MOTOR BRACKET INSTALLATION

1. Attach the optional TMB-S bracket to the transducer as shown in the following figure, using the hardware supplied with the transducer. (Note: The internal tooth washer is supplied with the TMB-S.)

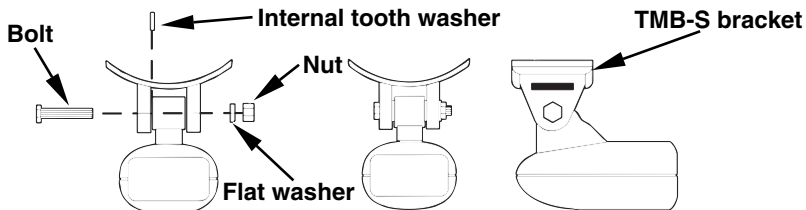

Attach motor mounting bracket to transducer.

2. Slide the adjustable strap supplied with the TMB-S through the slot in the transducer bracket and wrap it around the trolling motor. Position the transducer to aim straight down when the motor is in the water. Tighten the strap securely.
3. Route the transducer cable alongside the trolling motor shaft. Use plastic ties (not included) to attach the transducer cable to the trolling motor shaft. Make sure there is enough slack in the cable for the motor to turn freely. Route the cable to the sonar unit and the transducer is ready for use.

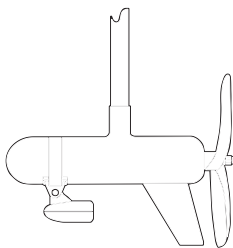

Transducer mounted on trolling motor, side view.

TRANSDUCER ORIENTATION AND FISH ARCHES

If you do not get good fish arches on your display, it could be because

the transducer is not parallel with the ground when the boat is at rest in the water or at slow trolling speeds.

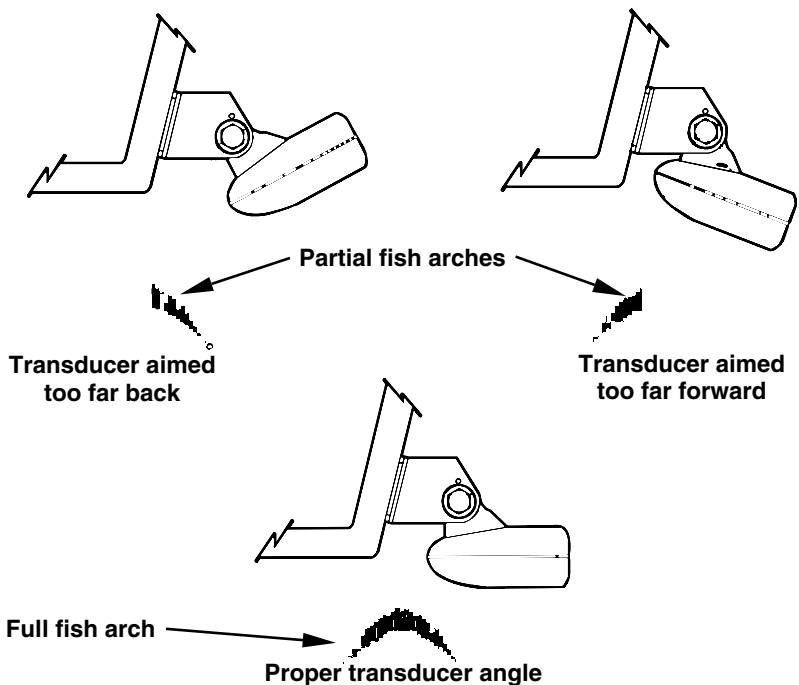

Transducer angles and their effects on fish arches.

If the arch slopes up – but not back down – then the front of the transducer is too high and needs to be lowered. If only the back half of the arch is printed, then the nose of the transducer is angled too far down and needs to be raised.

NOTE:

Periodically wash the transducer's face with soap and water to remove any oil film. Oil and dirt on the face will reduce the sensitivity or may even prevent operation.

SHOOT-THRU-HULL PREPARATION

The transducer installation inside a fiberglass hull must be in an area that does not have air bubbles in the resin or separated fiberglass layers. The sonar signal must pass through solid fiberglass. A successful transducer installation can be made on hulls with flotation materials (such as plywood, balsa wood or foam) between layers of fiberglass if the material is removed from the chosen area.

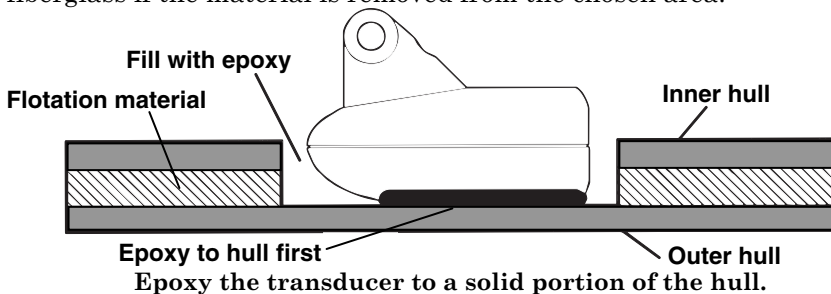

For example, some (but not all) manufacturers use a layer of fiberglass, then a core of balsa wood, finishing with an outer layer of fiberglass. Removing the inner layer of fiberglass and the balsa wood core exposes the outer layer of fiberglass. The transducer can then be epoxied directly to the outer layer of fiberglass. After the epoxy cures, the hull is watertight and structurally sound. Remember, the sonar signal must pass through solid fiberglass. Any air bubbles in the fiberglass or the epoxy will reduce or eliminate the sonar signals.

WARNING:

Do not remove any material from your inner hull unless you know the hull's composition. Careless grinding or cutting on your hull can result in damage that could sink your boat. Contact your boat dealer or manufacturer to confirm your hull specifications.

To choose the proper location for thru-hull mounting, anchor the boat in 60 feet of water. Add a little water to the sump of the boat. Plug the transducer into the sonar unit, turn it on, then hold the transducer over the side of the boat. Adjust the sensitivity and range controls until a

second bottom echo is seen on the display. (You will need to turn off both automatic and ASP™.) Don't touch the controls once they've been set.

Next, take the transducer out of the water and place it in the water in the sump of the boat. Observe the sonar signal to see if there is a noticeable decrease in sensitivity. The second bottom signal may disappear and the bottom signal may decrease in intensity.

Move the transducer around to find the best location. If the sensitivity control must be increased greatly to compensate, then the transducer should be mounted on the outside of the hull. If not, then mark the location that shot through the hull the best and follow the instructions on the following pages for a shoot-thru-hull mounting.

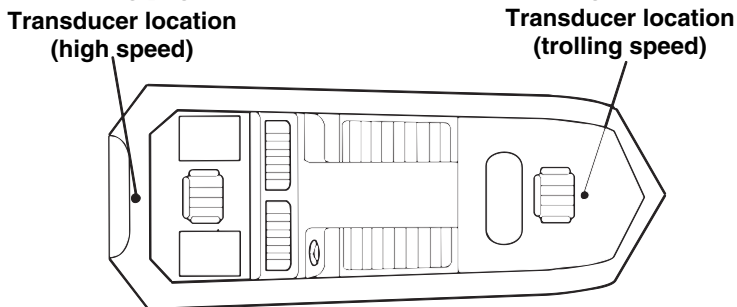

Shoot-thru-hull transducer locations for high speed or trolling speed operation.

Shoot-thru-hull Installation

1. Make sure the area is clean, dry and free of oil or grease, then sand both the inside surface of the hull and the face of the transducer with 100 grit sandpaper. The surface of the hull must be flat so the entire transducer face is in contact with the hull prior to bonding.

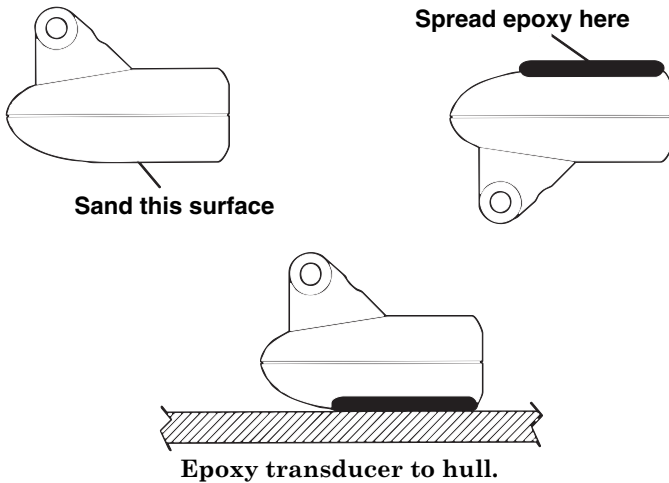

2. Follow the instructions on the epoxy package and mix it thoroughly. Do not mix it too fast, because it will cause bubbles to form in the epoxy. Apply a small amount on the face of the transducer as shown above, then spread a small amount onto the sanded area on the hull.

Place the transducer into the epoxy, twisting and turning it to force any air bubbles out from under the transducer face. The face of the transducer should be parallel with the hull, with a minimum amount of epoxy between the hull and transducer. After the epoxy dries, route the cable to the sonar unit.

POWER AND CABLE CONNECTIONS

The unit works from a 12-volt battery system. For the best results, attach the power cable directly to the battery. You can attach the power cable to an accessory or power buss, however you may have problems with electrical interference. Therefore, it's safer to go ahead and attach the power cable directly to the battery.

CAUTION:

When using the unit in a saltwater environment, we strongly recommend that you shut off the power supply to the power cable when the unit is not in use. When the unit is turned off but still connected to a power supply, electrolysis can occur in the power cable plug. This may result in corrosion of the plug body along with the electrical contacts in the cable and the unit's power socket.

In saltwater environments we recommend you connect the power cable to the auxiliary power switch included in most boat designs. If that results in electrical interference, or if such a switch is not available, we recommend connecting direct to the battery and installing an inline switch. This will let you shut off power to the power cable when the unit is not in use. When you are not using the unit, you should always shut off power to the power cable, especially when the power cable is disconnected from the unit.

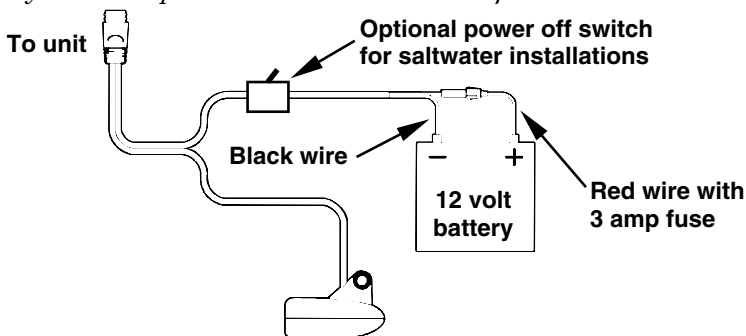

Power and transducer connections for the Cuda family sonar units (direct battery connection shown).

If possible, keep the power cable away from other boat wiring, especially the engine's wires. This will provide the best isolation from electrical noise. If the cable is not long enough, splice #18 gauge wire onto it. The power cable has two wires, red and black. Red is the positive lead, black is negative or ground. Make sure to attach the inline fuse holder to the red lead *as close to the power source as possible*.

For example, if you have to extend the power cable to the battery or power buss, attach one end of the fuse holder directly to the battery or power buss. This will protect both the unit and the power cable in the event of a short. It uses a 3-amp fuse.

CAUTION:

Do not use this product without a 3-amp fuse wired into the power cable! Failure to use a 3-amp fuse will void your warranty.

This unit has reverse polarity protection. No damage will occur if the power wires are reversed. However, the unit will not work until the wires are attached correctly.

MOUNTING THE SONAR UNIT: In-Dash or Bracket

You can install the sonar unit on the top of a dash with the supplied bracket. It can also be installed in the dash with an optional dash-mounting kit (FM-5 mount kit for Cuda 168EX, FM-6 mount kit for all others covered in this manual).

In-Dash Installation

For the Cuda 168EX

The following figure shows dimensions for in-dash mounting a Cuda 168EX. The in-dash adapter kit includes a template for cutting the mounting hole and complete installation directions on instruction sheet 988-0147-43.

NOTE:

The Cuda 168EX needs only one cable, but some of the other products covered by the FM-5 instruction sheet use more. When installing your unit, use the instructions for the transducer cable and ignore references to any others.

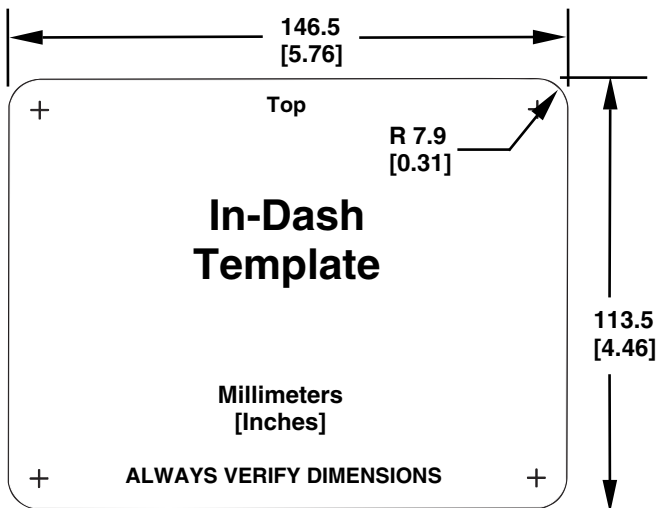

In-dash mounting template for Cuda 168EX, showing dimensions.

NOTE: The preceding figure is *not* printed to scale. A scaled template is available for free download from our web site, www.eaglesonar.com.

For the Cuda 128 and Cuda 168

The Cuda 128 and Cuda 168 both use the same case and can be mounted in-dash using the removable scaled template inside the back cover of this manual (page 55). The FM-6 mount kit includes the necessary materials, but the instructions only appear here in this manual.

Please read all the instructions before proceeding. **NOTE:** Recommended tools for this job include: jig saw, drill, drill bit (for starting hole).

1. Select the desired mounting location. Make sure there is enough room behind the dash to attach the unit's cable. The case is approximately 1-3/4" (45 mm) behind the mounting surface. You also need to allow an additional 1" (25 mm) for the power/transducer cable and connector.
2. Cut or tear out the template in the back of this manual (page 55) and tape it to the dash. Begin the cutout by drilling a starter hole near the center of the template. Use a drill bit big enough for the jigsaw blade.

3. Slip your saw blade into the starter hole and then cut along the outside line. Be careful when working around the corners, because there is little room for error.
4. Remove the backing from *one side* of the double-sided mounting tape contained in the mounting kit. Apply it to the outer ledge on the back of your unit. Starting at the bottom center, work the tape around all four sides of the unit. Cut off any excess tape when finished.
5. Attach the power/transducer cable to the back of the unit.
6. Remove the backing from the exposed side of the tape. Carefully place the unit into the dash cutout. Press down firmly around the entire outer edge to make sure the unit is secured to the dash.

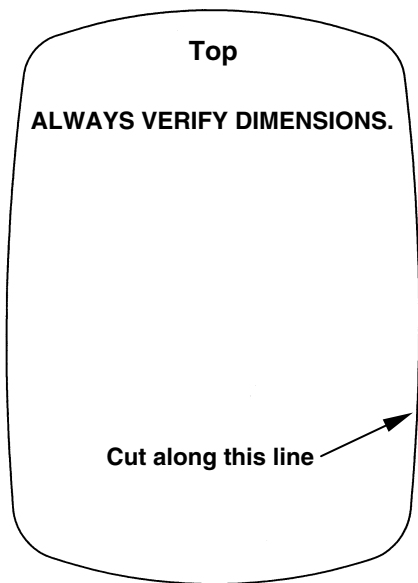

In-dash mounting template for Cuda 128 and Cuda 168. NOTE: This figure is *not* printed to scale. See the back of this manual for a scaled template copy you can tear out and use. Manual is available on our web site.

Bracket Installation

Mount the unit in any convenient location, provided there is clearance when it's tilted for the best viewing angle. You should also make sure there is enough room behind the unit to attach the power/transducer cable. (See the following drawings, which show the dimensions of a gimbal-mounted Cuda 168EX sonar unit and a Cuda 128 or 168.)

Holes in the bracket's base allow wood screw or through-bolt mounting. You may need to place a piece of plywood on the back side of thin panels to reinforce the panel and secure the mounting hardware.

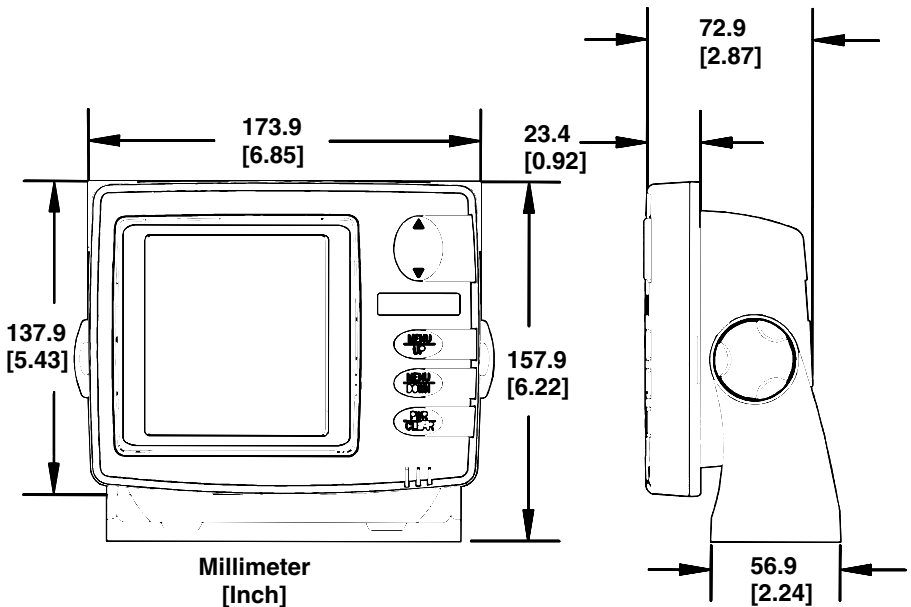

Front view (left) and side view (right) showing dimensions of Cuda 168EX when mounted on gimbal bracket.

Drill a 5/8" (15.9 mm) hole in the dash for the power/transducer cable. The best location for this hole is immediately under the gimbal bracket

location. This way, the bracket can be installed so that it covers the hole, holds the cable in position and results in a neat installation. Some customers, however, prefer to mount the bracket to the side of the cable hole — it's a matter of personal preference. After drilling the hole, pass the connector *up* through the hole from under the dash.

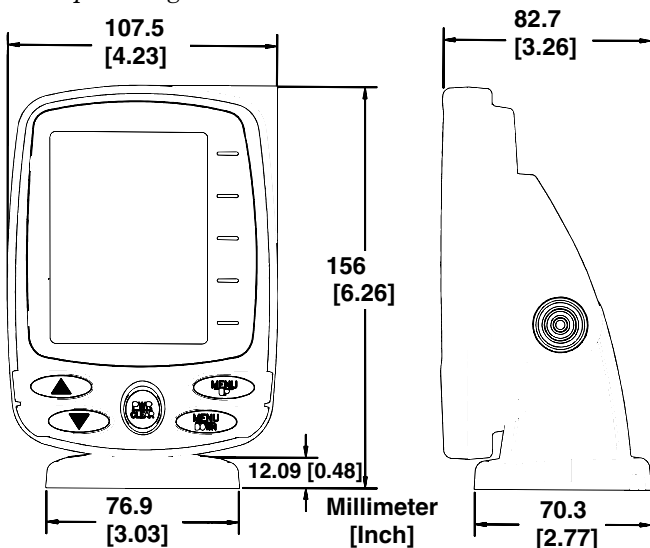

Front view (left) and side view (right) showing dimensions of the other Cuda family sonar units when mounted on quick release bracket.

If you wish, you can fill in the hole around the cable with a good marine caulking compound. (Some marine dealers stock cable hole covers to conceal the opening.) No matter what type of installation you prefer, be sure to leave enough slack in the cable to allow tilting or swiveling the unit.

For the Cuda 168EX

If you choose to fill in the cable hole, be sure to position the cable against the rear edge of the hole as you apply the fill material.

Before positioning the gimbal bracket, be sure to hold the cable against the rear edge of the hole. Then, slide the bracket over the hole and butt the rear of the bracket base firmly against the cable, thus pinning it in place against the side of the hole. Finally, fasten the bracket to the dash.

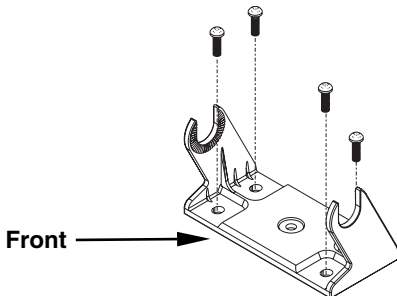

Install the gimbal bracket. Orient the bracket so the arms slope toward the front of your unit.

Attach the unit to the gimbal bracket using the supplied gimbal knobs and washers. Slide the rubber washers onto the gimbal knobs then loosely screw the knobs into their sockets. Slide the unit into the bracket with the rubber washers to the outside of the bracket arms. Tilt the unit to the desired viewing angle and tighten the knobs finger tight.

For the Cuda 128 and Cuda 168

These units use a quick release mounting bracket. When you run the cable through the hole, make sure you allow enough slack for tilting the unit and attaching the connector. (The snug fit of the push-on waterproof connector requires some force to attach.)

Align the bracket over the cable hole with the cable slots facing away from you and fit the cable through one of the slots. Fasten the bracket to the dash using the three screw holes.

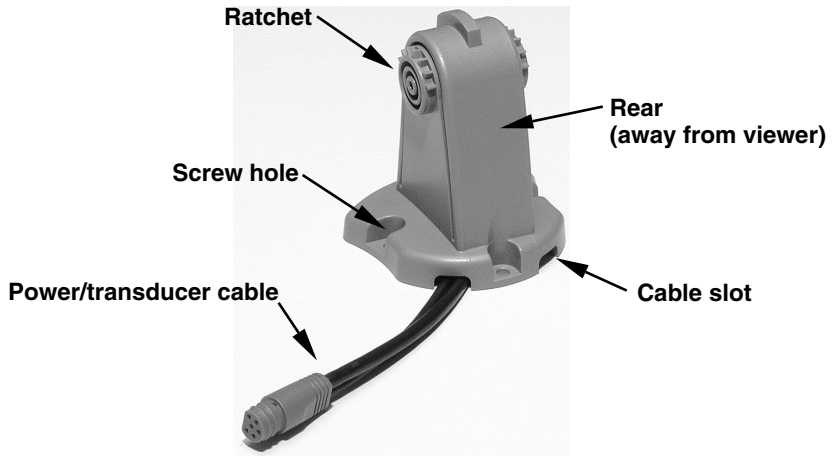

Cuda 128 and 168 quick release mounting bracket. Slots in the base allow routing the cable from beneath the mount.

Attach the unit to the bracket by first connecting the power/transducer cable. Then, hold the sonar unit vertically and slide it onto the bracket from above. (The back of the unit should be touching the front of the bracket as you lower it into position.) As you push down, the unit will lock into place with a distinct click.

To adjust the viewing angle, pinch the ratchets with one hand, then tilt the unit with your other hand. Release the ratchets and the unit locks into the new position. To dismount the unit for storage, press the ratchets and lift the unit off the bracket.

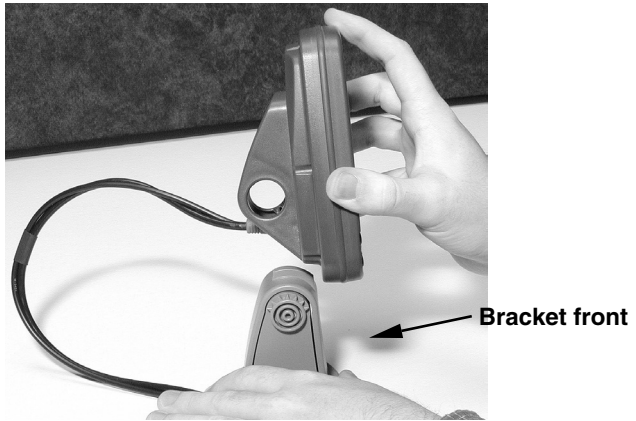

Mount the sonar: slide the unit onto the bracket from above.

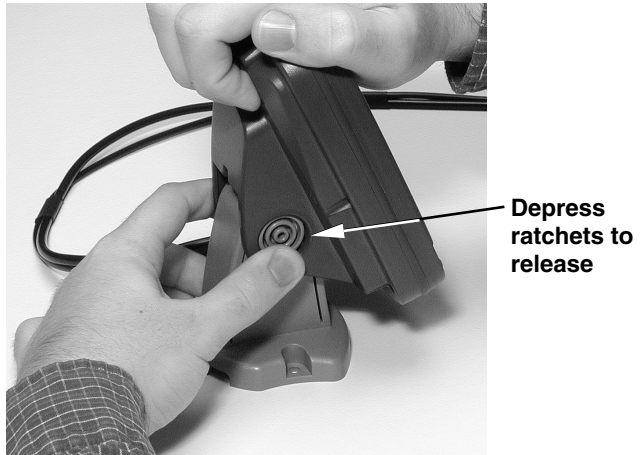

Adjust viewing angle: use one hand to press and release the spring-loaded ratchets while you move the unit with the other hand.

Portable Sonar Installation

Like many Eagle products, the Cuda sonar family is capable of portable

operation. The Cuda 168EX uses the optional PPP-13 portable power pack. The Cuda 128 and Cuda 168 use the optional PPP-12 portable power pack. In fact, the Cuda 128 Portable package includes the PPP-12 and the transducer necessary for portable use.

The power pack and portable or floating transducers expand the uses for your sonar. You can use your Cuda sonar unit on your boat or take it to the dock, on a float tube, on an ice fishing trip or use it as a second sonar in a friend's boat.

The PPP-12 or PPP-13 package includes the power pack, battery adapter and a portable transducer. Batteries are not included. Each power pack has a storage compartment for the portable transducer. The PPP-12 can be used with eight AA alkaline batteries. The PPP-13 can be used with eight D alkaline batteries or an optional sealed, rechargeable battery.

To use a portable power pack, you simply install the batteries and then attach the sonar unit to the power pack's bracket. Plug in the power/transducer cable and you're ready to fish.

(The PPP-12 has a quick-release mounting bracket built into the case. The PPP-13 requires you to attach the gimbal bracket to the case and then attach the sonar unit to the bracket with the supplied washers and knobs.)

Installing the Batteries

Release the latch on the front of the battery case. Open the compartment and install either an optional rechargeable battery, eight D batteries or eight AA batteries into the adapter. For the longest life, we recommend you use alkaline batteries.

NOTE:

When the unit is not in use, we recommend you unplug the power connector to reduce the possibility of corrosion or battery drain. When you store the unit, always remove the batteries because dead batteries can leak and corrode the contacts.

After installing the batteries, close the case and plug the sonar unit's power cable into the socket on the battery case.

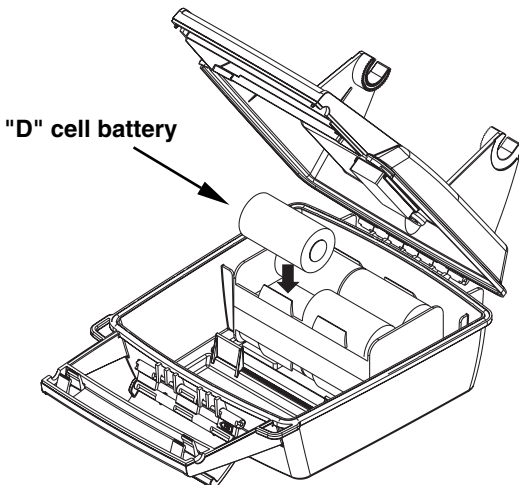

Install batteries in power case battery adapter. PPP-13 shown.

Turn the sonar unit on. If it doesn't work, make sure the battery terminals are making good contact against the battery contacts. Also check the wiring connections on the battery adapter. The red wire on the power cable should be attached to the red wire on the battery adapter and the power cable's black wire should be connected to the black wire on the battery adapter.

If it still doesn't work, check the battery voltage. Most of the complaints we receive about portable units result from stale batteries. Make sure the ones you buy are fresh.

In cold weather the efficiency of dry cell batteries drops with the temperature. We find it a good idea to have the sonar unit good and warm along with the batteries before we leave home.

If the batteries do lose a charge, you can sometimes restore them by placing them in a warm room or car interior. A better way is to replace them with batteries that have been kept warm.

WARNING:

Never heat the batteries over an open flame or direct hot air onto them. A fire or explosion could result.

Portable Transducer Assembly

Recommended tools for installation include a slotted screw driver and two adjustable wrenches.

Assemble the transducer and bracket as shown in the following figure. Attach the transducer to the bracket with the supplied hardware.

Make sure there is one washer on each side of the transducer, inside the bracket. Slide the other washer over the end of the bolt and thread the nut onto it.

Screw the suction cup onto the bracket using the supplied screw and flat washer. Tie the nylon cord through the hole in the top of the bracket. When using this transducer, tie the other end of the nylon cord to the boat. This will help prevent the loss of the transducer if it comes off the boat.

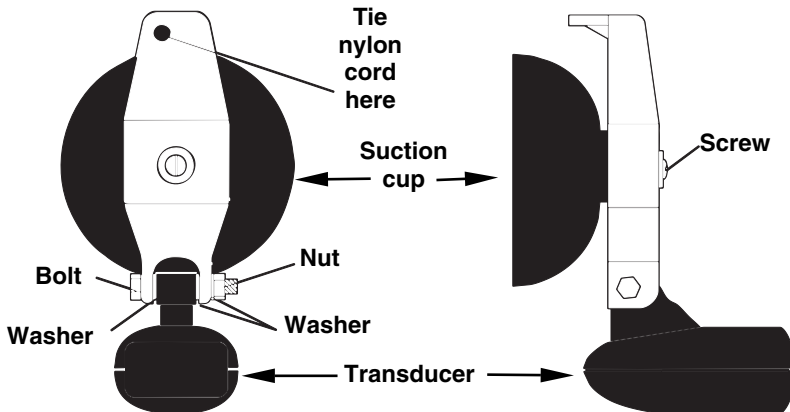

Portable transducer assembly: rear view (left) and side view (right.)

Clean the chosen area of the hull before attaching the suction cup. Locate the transducer on the hull as shown in the following figure. Don't allow the bracket to extend below the hull, because water pressure against it can cause the suction cup to come off at speed.

Moisten the cup, then press it onto the hull as firmly as possible. Tie the nylon cord to the boat and route the transducer cable to the sonar unit. Your portable sonar is now ready for use.

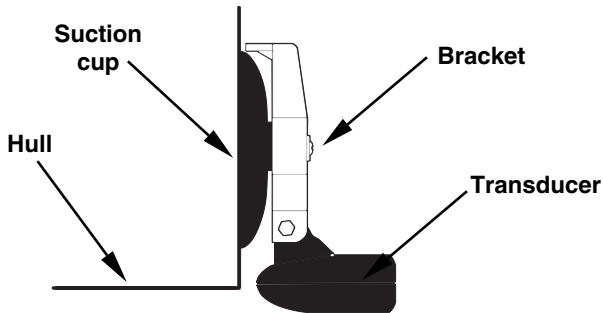

Portable transducer installed on boat transom.

NOTE:

For optimum operation, the portable transducer should be adjusted so that it is parallel to the ground. For more information on this, see the earlier segment on Transducer Orientation and Fish Arches.

Operation

KEYBOARD BASICS

The unit sounds a tone when you press any key. This tells you the unit has accepted a command. Numbers in the following photos correspond to key explanations in the following pages.:



Cuda 128 and Cuda 168EX Sonars, front view, each showing screen and keyboard.

1. PWR/CLEAR (power and clear)

This key appears in the manual text simply as **PWR**. Press this key to turn the unit on and off. It also clears menu selections and the menus from the screen. To clear a menu from the screen, press **PWR** one time.

NOTE:

You must hold the **PWR** key down for a countdown of five in order to turn the unit off.

2. MENU UP (menu up)

3. MENU DOWN (menu down)

These keys appear in the manual text as **MENU UP** or **MENU DOWN**. Most of the time, the instructions require you to press either menu key, so

the text simply uses the word **MENU**. Usually, when we say **MENU**, you can simply press the **MENU UP** key for consistency.

This sonar unit has many features that are accessed with the menu keys. The **MENU UP** key moves up or forward through the menus, the **MENU DOWN** key moves down or backward. To see the first menu, simply press either **MENU** key. To see the other menus, press a **MENU** key repeatedly to cycle through the menu list.

4. UP and DOWN ARROWS

These keys appear in the manual text as **DOWN ARROW** or **UP ARROW**. Use these keys to adjust virtually every feature and function on the sonar unit.

MEMORY

This unit has permanent memory that saves the following user settings when power is turned off: Units of Measure, Fish Alarm, Temp Size, Depth Size, Fish I.D. mode, Noise Reject mode, Display Contrast, Shallow and Deep alarms. It does not require, nor does it use an internal backup battery, so you never have to worry about replacement batteries.

MENUS

This unit uses menus to guide you through the various functions and features. Menu names and settings appear in the manual text as small capital letters like **SENSITIVITY**, which represents the Sensitivity menu.

The menu keys access these features, allowing you to customize the unit to your particular needs and water conditions. All you have to do to leave one menu and enter another is press **MENU** repeatedly. If you ever get lost in the menus, simply press the **PWR** key. This clears the menus from the screen.

Menus change depending on the mode the unit is in. Messages may appear in menu boxes or new menus can appear, depending on previous selections.

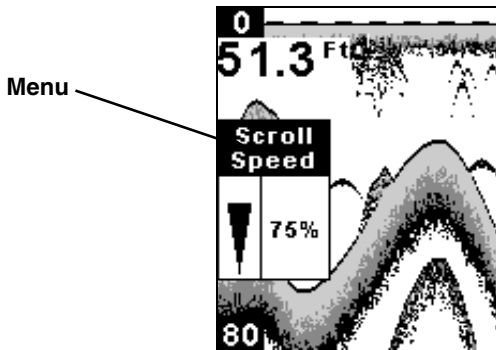

This screen shows a typical menu, the Scroll Speed menu.

DISPLAY – Opening Screen

The lights flash for about 20 seconds when the unit is turned on. The backlight menu first appears on the screen. To turn the lights on, press **UP ARROW**. If you don't press a key, the menu will disappear after a few seconds. If you don't want to wait, press **PWR** to clear the menus from the screen.

When the sonar unit is first turned on and the backlight menu disappears, the display screen shows the Full Chart Page, or mode. The Fish I.D.[™] fish symbol feature is on. The depth range shows on the depth scale on the left side of the screen. In the following figure, the screen shows a depth range from 0 to 80 feet and the bottom depth is 36.9 feet, shown by the digital sonar. The water temperature is 34.5° F.

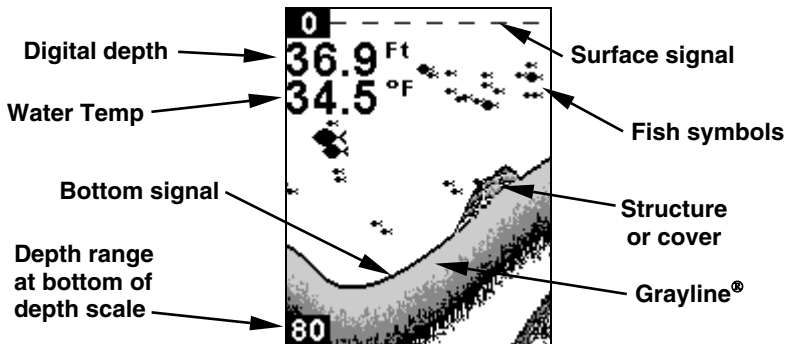

Opening screen, Full Chart page, or mode. The factory default setting has the Fish I.D. (fish symbols) turned on.

CHART SCROLL (stopping and starting)

In normal operation, the sonar chart will scroll from right to left across the screen. You can stop the chart from scrolling across the screen. This is useful when you want to "freeze" the picture to study it more closely.

To stop the chart, press **MENU** until the **SCROLL SPEED** menu appears. Use the **DOWN ARROW** to select **MIN**. The menu remains visible and a stationary "Stop" message appears in the screen's top right corner.

To resume scrolling, use the **UP ARROW** to select **MAX** (or any speed other than minimum), then press **PWR** to clear the menu. For most fishing conditions you should return the chart to maximum speed. (Read more about this in the later entry on Chart Scroll Speed.)

NOTE:

You cannot clear the menu until you raise the chart speed again. If you accidentally press **PWR** to clear the menu while the chart is stopped, you must press **MENU** until the **SCROLL SPEED** menu reappears, then follow the instructions from the preceding paragraph.

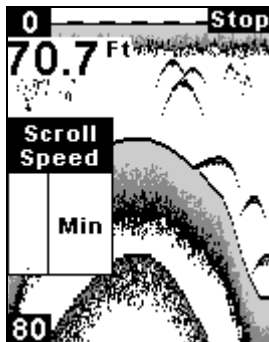

Sonar chart with scrolling stopped.

FULL CHART

This shows all echoes scrolling across the full screen. This is the default page. The bottom signal scrolls across the screen from right to left. The line at the top of the screen represents the surface. The bottom depth (as determined by the digital sonar) shows in the upper left corner.

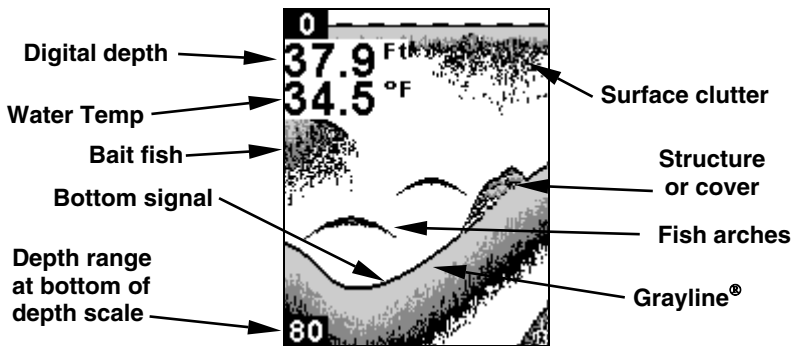

Full Chart page, showing digital depth (above) and temp (below). The Fish I.D. feature is turned off.

If the transducer with a built-in temperature sensor is connected, a digital display for water temperature will also be shown. This

temperature display can be turned on and off. See the later entry on Temperature Size for off and on instructions

DEPTH RANGE ZOOM (automatic and manual)



When turned on, the unit automatically adjusts the depth range according to water conditions. When in auto range mode, it always keeps the bottom displayed in the lower portion of the screen. You can over-ride the automatic depth range control and manually select a depth range.

To do this, press **MENU** until the **RANGE ZOOM** menu appears. Press the **DOWN ARROW** to select **MANUAL**, then press **MENU UP** to display the **RANGE SIZE** menu. Use the arrow keys to select a desired depth range. When you're finished, press **PWR** to clear the menu from the display.

This unit has the following depth ranges: 10, 20, 40, 80, 160, 320 and 640 feet.

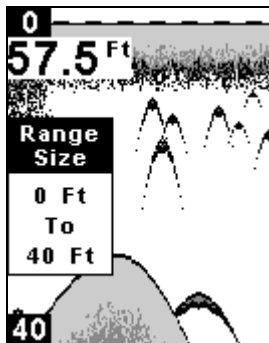

Range Size menu with manual depth range set to 40 feet. This in effect "zooms" or enlarges the display to show the water column from 0 to 40 feet deep. In this figure, the boat is in 57.5 feet of water, but only the top 40 feet of the water column is shown on the screen.

ZOOM

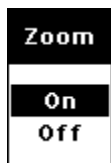

The zoom feature enlarges all images on the screen by doubling the size of the echoes (a 2X zoom). For example, if the current auto depth range is 0 to 60 feet, Zoom will show an enlarged view of the water column from 30 feet to 60 feet, always keeping the bottom in view.

To zoom the display, press the **MENU** key until the **ZOOM** menu appears. Press the **UP ARROW** key to select **ON**, then press **PWR** to clear the menu.

You can tell when the display is in Zoom mode because the top depth scale on the left of the screen will no longer show zero. For example, if the current range is 0 to 80 feet with zoom off, switching to zoom would enlarge the water column from 40 feet to 80 feet. The number 40 (instead of zero) would appear at the top of the depth range scale.

To turn the zoom feature off, press the **MENU** key until the **ZOOM** menu appears. Press the **DOWN ARROW** key to select **OFF**, then press **PWR** to clear the menu. The top of the depth range scale returns to zero.

NOTE:

Using the Zoom command while in *auto* depth Range Zoom mode will always enlarge the echoes near the bottom, because auto Range always keeps the bottom displayed in the lower portion of the screen.

When you Zoom while the unit is in *manual* depth Range Zoom mode, you can select one of 13 pre-set Zoom Sizes. This lets you enlarge some other particular segment of the water column.

To do this, first make sure the depth Range Zoom is in manual mode. (See previous instructions for Depth Range Zoom.) Next, press the **MENU** key until the **ZOOM** menu appears. Press the **UP ARROW** key to select **On**, then press **MENU UP** to display the **ZOOM SIZE** menu.

Use the arrow keys to select a desired zoom size. When you're finished, press **PWR** to clear the menu from the display.

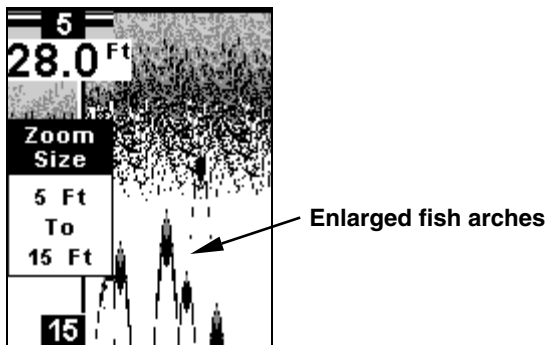

Zoom Size menu with the 5-15 foot zoom selected. The boat is in 28 feet of water, but the screen has zoomed in on the water column from 5 to 15 feet below the surface.

You can select from these zoom size ranges: 0-10, 5-15, 10-20, 15-30, 20-40, 30-60, 40-80, 60-120, 80-160, 120-140, 160-320, 240-480 and 320-640.

SENSITIVITY



Sensitivity controls the unit's ability to pick up echoes. If you want to see more detail, try increasing the sensitivity, a little at a time. There are situations when too much clutter appears on the screen. Decreasing the sensitivity can reduce the clutter and show the strongest fish echoes, if fish are present. As you change the sensitivity setting, you can see the difference on the chart as it scrolls.

You can change the sensitivity level whether you are in Auto Sensitivity mode or Manual Sensitivity mode. The adjustment method works the same in both modes, but it gives you slightly different results.

Adjusting sensitivity in Auto Sensitivity Mode is similar to manually

adjusting a car's speed with the accelerator pedal while cruise control is on. You can tell the car to run faster, but when you let off the gas the cruise control *automatically* keeps you from running slower than the minimum speed setting.

In your unit, auto mode will let you increase sensitivity to 100 percent, but the unit will *limit* your *minimum* setting. This prevents you from turning sensitivity down too low to allow automatic bottom tracking. When you change the setting with auto turned on, the unit will continue to track the bottom and make minor adjustments to the sensitivity level, with a bias toward the setting you selected.

Adjusting sensitivity in Manual Sensitivity Mode is similar to driving a car without cruise control — you have *complete* manual control of the car's speed. In your unit, manual mode allows you to set sensitivity at 100 percent (maximum) or zero percent (minimum.) Depending on water and bottom conditions, the bottom signal may completely disappear from the screen when you reduce sensitivity to about 45 percent or less!

Try adjusting sensitivity in both auto and manual modes to see how they work.

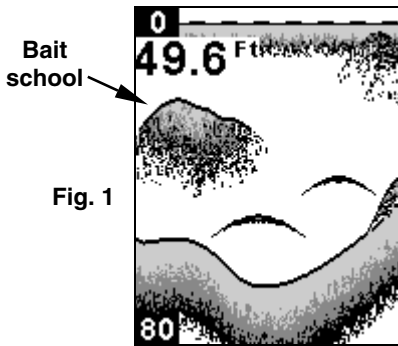

Fig. 1

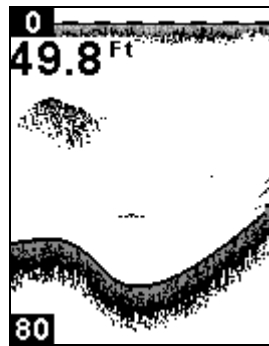

Fig. 2

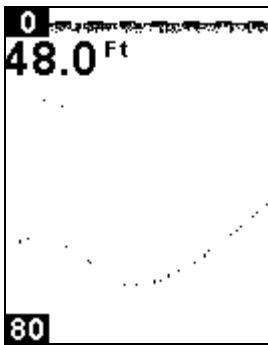

Fig. 3

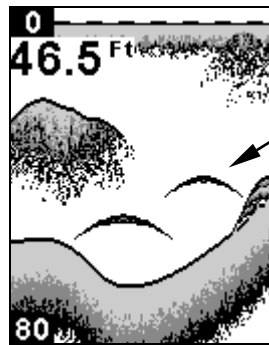
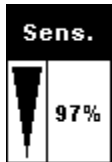

Fig. 4

These figures show results of different sensitivity levels on the same location. Fig. 1: Sensitivity at 98 percent, determined by Auto Sensitivity. Typical of full auto mode. Fig. 2: Sensitivity set at 71 percent. Fig. 3: Sensitivity set at 47 percent. Fig. 4: Sensitivity set at 100 percent.

To adjust sensitivity:



Press **MENU** until the **SENSITIVITY ADJUSTMENT** menu appears. Press **UP ARROW** to increase the sensitivity, **DOWN ARROW** to decrease it. When it's set at the desired level, press **PWR** to clear the menu.

The sensitivity percentage in use shows in this menu. As you change the setting, echoes scrolling onto the screen will show the effects of the change. If you reach the maximum or minimum sensitivity level, a tone sounds alerting you to the limits.

NOTE:

If you want to change the sensitivity in Manual Mode, first turn off Auto Sensitivity: press **MENU** until the **SENSITIVITY AUTOMATIC/MANUAL** menu appears. Press **DOWN ARROW** to select **MANUAL**, then press **PWR** to clear the menu. To adjust the sensitivity, follow the same steps used for adjusting sensitivity in auto mode above.

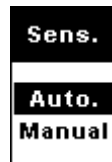

GRAYLINE®

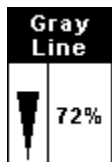

Grayline® lets you distinguish between strong and weak echoes. It "paints" gray on targets that are stronger than a preset value. This allows you to tell the difference between a hard and soft bottom. For example, a soft, muddy or weedy bottom returns a weaker signal which is shown with a narrow or no gray line. A hard bottom returns a strong signal which causes a wide gray line.

If you have two signals of equal size, one with gray and the other without, then the target with gray is the stronger signal. This helps distinguish weeds from trees on the bottom, or fish from structure.

Grayline is adjustable. The factory default for this unit is 72 percent. Since Grayline shows the difference between strong and weak signals, adjusting the sensitivity may also require a different Grayline level. The level chosen by the sonar unit at power on is usually adequate for most conditions. Experiment with your unit to find the Grayline setting that's best for you.

To change the Grayline level, press **MENU** until the **GRAYLINE** menu appears.

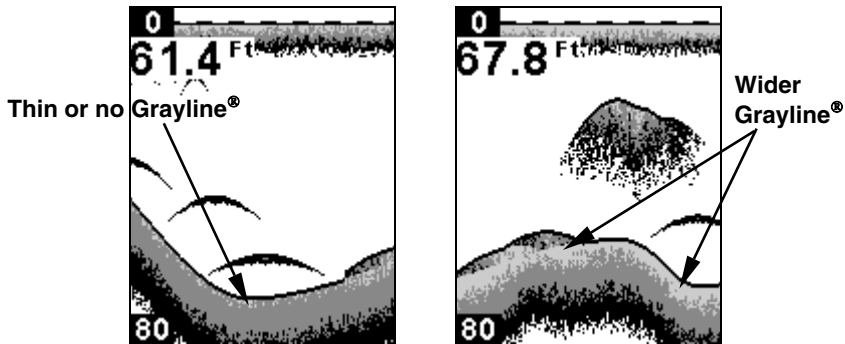

At left, little Grayline indicates a soft bottom, probably sand or mud.

At right, the wider Grayline indicates a harder, rocky bottom.

Press **UP ARROW** to increase the level or press **DOWN ARROW** to decrease it. The percentage of Grayline in use shows in this menu. Echoes scrolling onto the screen will also show the effects of the Grayline change. If you reach the maximum or minimum level, a tone sounds alerting you to the limits. Press **PWR** to clear the menu.

FISH I.D.™

The Fish I.D.™ feature identifies targets that meet certain conditions as fish. The microcomputer analyses all echoes and eliminates surface clutter, thermoclines and other signals that are undesirable. In most instances, remaining targets are fish.

The Fish I.D. feature displays symbols on the screen in place of the actual fish echoes. There are three symbol sizes: small, medium and large. These show the relative size between targets. In other words, it displays a small fish symbol when it thinks a target is a small fish, a medium fish symbol on a larger target and so forth.

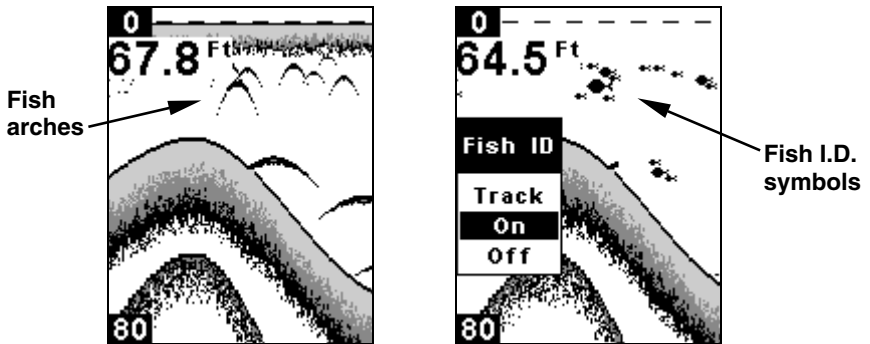

At left, underwater scene in normal fish arch mode. Right, Fish I.D. menu with the feature turned on.

Fish I.D. is an easier way for a sonar novice to recognize a fishy signal return when he sees it. However, locating fish by symbol *only* has some limitations.

Your sonar unit's microcomputer is sophisticated, but it can be fooled. It can't distinguish between fish and other suspended objects such as trotlines, turtles, submerged floats, air bubbles, etc. Individual tree limbs extending outward from a group of limbs are the hardest objects for the Fish I.D. feature to distinguish from fish.

To see what's under your boat in maximum detail, we recommend you turn off Fish I.D. and begin learning to interpret fish arches.

You may see Fish I.D. symbols on the screen when actually, there are no fish. The reverse is also true — Fish I.D. can actually miss fish that are present. Does that mean Fish I.D. is broken? No — the feature is simply interpreting sonar returns in a specific way to help take some of the work out of reading the screen. Remember: Fish I.D. is one of the many tools we provide so you can analyze your sonar returns for maximum fish finding information. This and other features can help you successfully "see" beneath the boat under varied water and fishing conditions. So, practice with the unit in both the Fish I.D. mode and without to become more familiar with the feature. This unit's default Fish I.D. setting is on.

Fish I.D. is most handy when you're in another part of the boat or performing some task that prevents you from watching the sonar screen. Then, you can turn on Fish I.D. and the audible **FISH ALARM**. When that lunker swims under your boat, you'll hear it!

Fish I.D. can also be useful when you want to screen out some of the sonar detail gathered by your unit. For example, it can help cut through the clutter of suspended bubbles caused by wave action or boat wakes.

To turn Fish I.D. off, press **MENU** until the **FISH ID** menu appears. Press **DOWN ARROW** to select **OFF**, then press **PWR**. To turn it back on, repeat the above steps, but press **UP ARROW** to select **ON**.

FISHTRACK™

The FishTrack™ feature shows the depth of a fish symbol when it appears on the display. To turn it on, press **MENU** until the **FISH ID** menu appears. Press **UP ARROW** to select **TRACK ON**, then press **PWR**. To turn it off, repeat the above steps, but press **DOWN ARROW** to select **OFF**. (If you want to turn off FishTrack depths but leave Fish I.D. on, press **DOWN ARROW** to select **ON**, then press **PWR**.) Remember, Fish I.D. must be on in order to use the FishTrack feature.



Fish I.D. symbols showing FishTrack depth indicator

Fish ID menu and symbol with FishTrack on. The fish is 44 feet deep.

CHART SCROLL SPEED



The rate that echoes scroll across the screen is called the chart scroll speed. The default for this unit is "max" (100 percent); we recommend that you leave the scroll speed set there for virtually all fishing conditions.

However, you might consider experimenting with chart speed when you are stationary or drifting very slowly. You may sometimes achieve better images as you slow down the chart speed to match how fast you are moving across the bottom.

If you are at anchor, ice fishing or fishing from a dock, experiment with a chart speed of 20 percent. If you are drifting slowly, try a chart speed of 50 percent. When you are stationary and a fish swims through the sonar signal cone, the image appears on the screen as a long line instead of a fish arch. Reducing the chart speed may result in a shorter line that more closely resembles a regular fish return.

Adjust scroll speed by pressing **MENU** until **SCROLL SPEED** appears. Press **UP ARROW** to increase it and press **DOWN ARROW** to decrease it. Press **PWR** to clear the menu.

To return to the original setting, repeat the above steps, but use the arrow keys to set the speed at **MAX** before clearing the menu.

NOISE REJECT and ASP™ (Advanced Signal Processing)



The ASP™ (Advanced Signal Processing) feature is a noise rejection system built into the sonar unit. It constantly evaluates the effects of boat speed, water conditions and electrical interference and automatically gives you the best display possible under most conditions.

ASP is an effective tool in combating noise. In sonar terms, noise is any undesired signal. It is caused by electrical and mechanical sources such as bilge pumps, engine ignition systems and wiring, air bubbles passing

over the face of the transducer, even vibration from the engine. In all cases, noise can produce unwanted marks on the display.

The ASP noise rejection feature is especially useful because it typically lets you operate the boat at all speeds without adjusting the sensitivity or other controls.

The ASP feature has three settings — Off, Low and High. When first turned on, noise rejection is set on low. If you have high noise levels, try using the high ASP setting. However, if you are having trouble with noise, we suggest that you take steps to find the interference source and fix it, rather than continually using the unit with the high ASP setting.

There are times when you may want to turn ASP off. This allows you to view all incoming echoes before they are processed by the ASP feature.

To change the ASP setting, press **MENU DOWN** until **NOISE REJECT** appears. Use the up and down arrow keys to select the desired setting, then press **PWR** to clear the menu.

ALARMS

The sonar unit has three different types of alarms: fish, shallow and deep.

Fish Alarm



The Fish Alarm sounds a tone when a fish symbol appears on the screen. The default setting is on, but the Fish I.D. feature must be turned on for fish alarms to work.

To turn Fish I.D. on, press **MENU** until the **FISH ID** menu appears. Press **UP ARROW** to select **ON**, then press **PWR**. Then, press **MENU** until the **FISH ALARM** menu appears. Press **UP ARROW** to select **ON**, then press **PWR**.

To turn off the fish alarm without turning off fish symbols, press **MENU DOWN** until **FISH ALARM** appears. Press **DOWN ARROW** to select **OFF**, then

press **PWR** to clear the menu. Repeat the above steps to turn the alarm back on, but press **UP ARROW** to select **ON** before clearing the menu.

Depth Alarms

The depth alarms are triggered only by the bottom signal. No other echoes will activate these alarms. The depth alarms consist of a shallow and a deep alarm. The shallow alarm sounds an alarm tone when the bottom goes shallower than the alarm's setting. The deep alarm sounds a tone when the bottom goes deeper than its setting. Both alarms adjust the same way, although through different menus.

Shallow Alarm

Shallow Alarm To set the shallow alarm depth, press **MENU DOWN** repeatedly until **SHALLOW ALARM** appears.

6 Feet Press **UP ARROW** to increase the shallow alarm's depth setting or press **DOWN ARROW** to decrease it. The number in the shallow alarm's menu box shows the current shallow alarm setting. When the number reaches the desired setting, press **PWR** to clear the menu. When the bottom depth goes shallower than the alarm's setting, an alarm tone sounds and a message box appears on the screen.

Press **PWR** to silence the alarm. This turns the alarm sound off until the shallow alarm is triggered again.

To turn the alarm off, press **MENU DOWN** repeatedly until **SHALLOW ALARM** appears. Press **DOWN ARROW** until the words **OFF FEET** appear, then press **PWR** to clear the menu.

Deep Alarm

Deep Alarm To set the deep alarm depth, press **MENU DOWN** repeatedly until **DEEP ALARM** appears.

70 Feet Press **UP ARROW** to increase the deep alarm's depth setting or press **DOWN ARROW** to decrease it. The number in the deep alarm's menu box shows the current deep alarm

setting. When the number reaches the desired setting, press **PWR** to clear the menu. When the bottom depth goes deeper than the alarm's setting, an alarm tone sounds and a message box appears on the screen.

Press **PWR** to silence the alarm. This turns the alarm sound off until the deep alarm is triggered again.

To turn the alarm off, press **MENU DOWN** repeatedly until **DEEP ALARM** appears. Press **DOWN ARROW** until the words **OFF FEET** appear, then press **PWR** to clear the menu.

DISPLAY ADJUSTMENTS

BACKLIGHTS

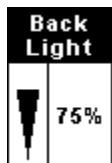

The display is backlit for night use. To turn the backlight on or off, press **MENU** repeatedly until the **BACK LIGHT** menu appears. Press **UP ARROW** to turn the light on or the **DOWN ARROW** to turn it off.

DISPLAY CONTRAST

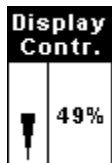

The unit's display contrast is adjustable to suit different lighting conditions. This will help you see the screen from different angles or at various times of the day. The default setting is min (minimum) percent.

To adjust the contrast, press **MENU DOWN** until the **DISPLAY CONTRAST** menu appears. To decrease screen contrast, press the **DOWN ARROW** key. Press the **UP ARROW** key to increase screen contrast. The bar graph in the Contrast menu box shows a graph of the contrast. The screen will also show the effects of the change. If you reach the maximum or minimum level, a tone sounds alerting you to the limits. Press the **PWR** key to clear the menu.

DEPTH UNITS OF MEASURE



This unit can show the depth in feet or meters.

To change the depth units of measure, press **MENU DOWN** until the **UNITS** menu appears. Use the arrow keys to select the desired unit of measure, then press the **PWR** key to clear the menu.

PRESET UNIT (reset all options)

This command is used to reset all features, options and settings to their original factory defaults. This is useful when you have changed several settings and want to return the unit to basic automatic operation.

Turn the unit off. Press and hold the **DOWN ARROW** key and the **MENU DOWN** key at the same time while you press the **PWR** key. Release the keys as the unit powers up. The unit will turn on with factory settings restored.

SYSTEM INFO

To show the operating software system information, press **MENU DOWN** until the **UNIT INFO** menu appears. Press **PWR** to clear the screen.

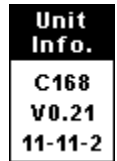

SIMULATOR

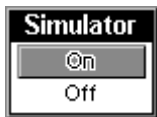

This unit has a built-in simulator that shows a simulated bottom signal with fish signals. This lets you practice with the unit as if you were on the water; all features and functions of the unit are usable. A message appears occasionally to remind you that the simulator is on.

To use the simulator, press **MENU DOWN** repeatedly until the **SIMULATOR** menu appears. Press **UP ARROW** to turn it on, and press **PWR** to clear the menu. Repeat the above steps to turn it off, or you can simply turn the unit off and back on again.

DIGITAL DATA SIZE FOR DEPTH and TEMPERATURE



The size of the digital numbers for the depth be changed to medium or large. The digital display for both Depth and Temperature can also be turned off or on.

To change either of these options, press **MENU DOWN** until either the **DEPTH SIZE** or **TEMP SIZE** menu appears, then use the **ARROW** keys to select the desired option. Press the **PWR** key to clear the menus.

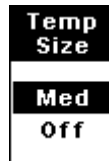

Troubleshooting

If your unit is not working, or if you need technical help, please use the following troubleshooting section before contacting the factory customer service department. It may save you the trouble of returning your unit for repair. For contact information, refer to the last page, just inside the back cover of this manual.

Unit won't turn on:

1. Check the power cable's connection at the unit. Also check the wiring.
2. Make certain the power cable is wired properly. The red wire connects to the positive battery terminal, black to negative or ground.
3. Check the fuse.
4. Measure the battery voltage at the unit's power connector. It should be at least 11 volts. If it isn't, the wiring to the unit is defective, the battery terminals or wiring on the terminals are corroded, or the battery needs charging.

Unit turns on only in simulator mode:

There is a problem with the transducer or the transducer cable. Check the cable for damage.

Unit freezes, locks up, or operates erratically:

1. Electrical noise from the boat's motor, trolling motor, or an accessory may be interfering with the sonar unit. Rerouting the power and transducer cables away from other electrical wiring on the boat may help. Route the sonar unit's power cable directly to the battery instead of through a fuse block or ignition switch
2. Inspect the transducer cable for breaks, cuts, or pinched wires.
3. Check both the transducer and power connectors. Make certain both are securely plugged in to the unit.

Weak bottom echo, digital readings erratic, or no fish signals:

1. Make certain the transducer is pointing straight down. Clean the face of the transducer. Oil, dirt and fuel can cause a film to form on the transducer, reducing its effectiveness. If the transducer is mounted inside the hull, be sure it is shooting through only one layer of fiberglass and that it is securely bonded to the hull. Do NOT use RTV silicone rubber adhesive or Marine-Tex™ epoxy.

2. Electrical noise from the boat's motor can interfere with the sonar. This causes the sonar to automatically increase its Discrimination or noise rejection feature. This can cause the unit to eliminate weaker signals such as fish or even structure from the display.

3. The water may be deeper than the sonar's ability to find the bottom. If the sonar can't find the bottom signal while it's in the automatic mode, the digital sonar display will flash continuously. It may change the range to limits far greater than the water you are in. If this happens, place the unit in the manual mode, then change the range to a realistic one, (for example, 0-100 feet) and increase the sensitivity. As you move into shallower water, a bottom signal should appear.

4. Check the battery voltage. If the voltage drops, the unit's transmitter power also drops, reducing its ability to find the bottom or targets.

Bottom echo disappears at high speeds or erratic digital reading or weak bottom echo while boat is moving

1. The transducer may be in turbulent water. It must be mounted in a smooth flow of water in order for the sonar to work at all boat speeds. Air bubbles in the water disrupt the sonar signals, interfering with its ability to find the bottom or other targets. The technical term for this is cavitation.

2. Electrical noise from the boat's motor can interfere with the sonar. This causes the sonar to automatically increase its Discrimination or noise rejection feature. This can cause the unit to eliminate weaker signals such as fish or even structure from the display. Try using resistor

spark plugs or routing the sonar unit's power and transducer cables away from other electrical wiring on the boat.

No fish arches when the Fish I.D. feature is off:

1. Make certain the transducer is pointing straight down. This is the most common problem if a partial arch is displayed.
2. The sensitivity may not be high enough. In order for the unit to display a fish arch, it has to be able to receive the fish's echo from the time it enters the cone until it leaves. If the sensitivity is not high enough, the unit shows the fish only when it is in the center of the cone.
3. Use the Zoom feature. It is much easier to display fish arches when zoomed in on a small range of water than a large one. For example, you will have much better luck seeing fish arches with a 30 to 60 foot range than a 0 to 60 foot range. This enlarges the targets, allowing the display to show much more detail.
4. The boat must be moving at a slow trolling speed to see fish arches. If the boat is motionless, fish stay in the cone, showing on the screen as straight horizontal lines.

NOISE

A major cause of sonar problems is electrical noise. This usually appears on the sonar's display as random patterns of dots or lines. In severe cases, it can completely cover the screen with black dots, or cause the unit operate erratically, or not at all.

To eliminate or minimize the effects of electrical noise, first try to determine the cause. With the boat at rest in the water, the first thing you should do is turn all electrical equipment on the boat off. Make sure the engine is also off. Turn your sonar on, then turn off Noise Reject [also known as the ASP feature (Advanced Signal Processing)]. Sensitivity should be set at 90-95 percent. There should be a steady bottom signal on the display. Now turn on each piece of electrical equipment on the boat and view the effect on the sonar's display. For

example, turn on the bilge pump and view the sonar display for noise. If no noise is present, turn the pump off, then turn on the VHF radio and transmit. Keep doing this until all electrical equipment has been turned on, their effect on the sonar display noted, then turned off.

If you find noise interference from an electrical instrument, trolling motor, pump, or radio, try to isolate the problem. You can usually reroute the sonar unit's power cable and transducer cable away from the wiring that is causing the interference. VHF radio antenna cables radiate noise when transmitting, so be certain to keep the sonar's wires away from it. You may need to route the sonar unit's power cable directly to the battery to isolate it from other wiring on the boat.

If no noise displays on the sonar unit from electrical equipment, then make certain everything except the sonar unit is turned off, then start the engine. Increase the RPM with the gearshift in neutral. If noise appears on the display, the problem could be one of three things; spark plugs, alternator, or tachometer wiring. Try using resistor spark plugs, alternator filters, or routing the sonar unit's power cable away from engine wiring. Again, routing the power cable directly to the battery helps eliminate noise problems. Make certain to use the in-line fuse supplied with the unit when wiring the power cable to the battery.

When no noise appears on the sonar unit after all of the above tests, then the noise source is probably cavitation. Many novices or persons with limited experience make hasty sonar installations which function perfectly in shallow water, or when the boat is at rest. In nearly all cases, the cause of the malfunction will be the location and/or angle of the transducer. The face of the transducer must be placed in a location that has a smooth flow of water at all boat speeds. Read your transducer owner's manual for the best mounting position.

Notes

If the dash mount template on page 55 has been removed from this manual, a free replacement manual containing the template can be downloaded from our web site, www.eaglesonar.com.

Top

ALWAYS VERIFY DIMENSIONS.

Measure the reference cross-hair below to confirm that this template is printed to the correct scale. The vertical line and the horizontal line should each be 2 inches long (50.8 mm.)

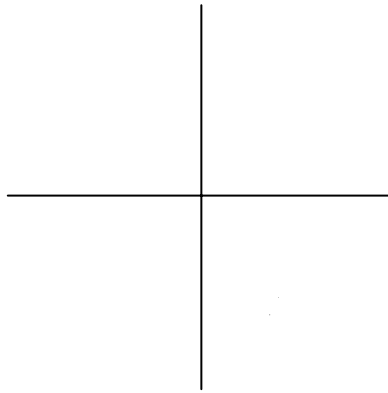

Cut along this line

Print only at 100% scale -- do not fit to page, do not enlarge or shrink.

In-dash mounting template for Cuda 128 and Cuda 168.

NOTE: *This figure is printed to scale. For use with FM-6 mount kit.*

Notes

EAGLE ELECTRONICS FULL ONE-YEAR WARRANTY

"We," "our," or "us" refers to EAGLE ELECTRONICS, a division of LEI, the manufacturer of this product. "You" or "your" refers to the first person who purchases this product as a consumer item for personal, family, or household use.

We warrant this product against defects or malfunctions in materials and workmanship, and against failure to conform to this product's written specifications, all for one (1) year from the date of original purchase by you. WE MAKE NO OTHER EXPRESS WARRANTY OR REPRESENTATION OF ANY KIND WHATSOEVER CONCERNING THIS PRODUCT. Your remedies under this warranty will be available so long as you can show in a reasonable manner that any defect or malfunction in materials or workmanship, or any non-conformity with the product's written specifications, occurred within one year from the date of your original purchase, which must be substantiated by a dated sales receipt or sales slip. Any such defect, malfunction, or non-conformity which occurs within one year from your original purchase date will either be repaired without charge or be replaced with a new product identical or reasonably equivalent to this product, at our option, within a reasonable time after our receipt of the product. If such defect, malfunction, or non-conformity remains after a reasonable number of attempts to repair by us, you may elect to obtain without charge a replacement of the product or a refund for the product. THIS REPAIR, OR REPLACEMENT OR REFUND (AS JUST DESCRIBED) IS THE EXCLUSIVE REMEDY AVAILABLE TO YOU AGAINST US FOR ANY DEFECT, MALFUNCTION, OR NON-CONFORMITY CONCERNING THE PRODUCT OR FOR ANY LOSS OR DAMAGE RESULTING FROM ANY OTHER CAUSE WHATSOEVER. WE WILL NOT UNDER ANY CIRCUMSTANCES BE LIABLE TO ANYONE FOR ANY SPECIAL, CONSEQUENTIAL, INCIDENTAL, OR OTHER INDIRECT DAMAGE OF ANY KIND.

Some states do not allow the exclusion or limitation of incidental or consequential damages, so the above limitations or exclusions may not apply to you.

This warranty does NOT apply in the following circumstances: (1) when the product has been serviced or repaired by anyone other than us; (2) when the product has been connected, installed, combined, altered, adjusted, or handled in a manner other than according to the instructions furnished with the product; (3) when any serial number has been effaced, altered, or removed; or (4) when any defect, problem, loss, or damage has resulted from any accident, misuse, negligence, or carelessness, or from any failure to provide reasonable and necessary maintenance in accordance with the instructions of the owner's manual for the product.

We reserve the right to make changes or improvements in our products from time to time without incurring the obligation to install such improvements or changes on equipment or items previously manufactured.

This warranty gives you specific legal rights and you may also have other rights which may vary from state to state.

REMINDER: You must retain the sales slip or sales receipt proving the date of your original purchase in case warranty service is ever required.

**EAGLE ELECTRONICS
PO BOX 669, CATOOSA, OK 74015
(800) 324-1354**

How to Obtain Service...

...in the USA:

We back your investment in quality products with quick, expert service and genuine Eagle replacement parts. If you're in the United States and you have technical, return or repair questions, please contact the Factory Customer Service Department. Before any product can be returned, you must call customer service to determine if a return is necessary. Many times, customer service can resolve your problem over the phone without sending your product to the factory. To call us, use the following toll-free number:

800-324-1354

8 a.m. to 5 p.m. Central Standard Time, M-F

Eagle Electronics may find it necessary to change or end our shipping policies, regulations, and special offers at any time. We reserve the right to do so without notice.

...in Canada:

If you're in Canada and you have technical, return or repair questions, please contact the Factory Customer Service Department. Before any product can be returned, you must call customer service to determine if a return is necessary. Many times, customer service can resolve your problem over the phone without sending your product to the factory. To call us, use the following toll-free number:

800-661-3983

905-629-1614 (not toll-free)

8 a.m. to 5 p.m. Eastern Standard Time, M-F

...outside Canada and the USA:

If you have technical, return or repair questions, contact the dealer in the country where you purchased your unit. To locate a dealer near you, visit our web site, www.eaglesonar.com and look for the Dealer Locator.

Accessory Ordering Information for all countries

To order Eagle accessories such as power cables or transducers, please contact:

1) Your local marine dealer or consumer electronics store. Most quality dealers that handle marine electronic equipment or other consumer electronics should be able to assist you with these items.

To locate an Eagle dealer near you, visit our web site, www.eaglesonar.com and look for the Dealer Locator. Or, you can consult your telephone directory for listings.

2) U.S. customers: LEI Extras Inc., PO Box 129, Catoosa, OK 74015-0129
Call 1-800-324-0045 or visit our web site www.lei-extras.com.

3) Canadian customers can write:

Lowrance/Eagle Canada, 919 Matheson Blvd. E. Mississauga, Ontario L4W2R7 or fax 905-629-3118.

Shipping Information

If it becomes necessary to send a product for repair or replacement, you must first receive a return authorization number from Customer Service. Products shipped without a return authorization will not be accepted. When shipping, we recommend you do the following:

1. Always use the original shipping container and filler material the product was packed in.
2. Always insure the parcel against damage or loss during shipment. Eagle does not assume responsibility for goods lost or damaged in transit.
3. For proper testing, include a brief note with the product describing the problem. Be sure to include your name, return shipping address and a daytime telephone number.

Visit our web site:



www.eaglesonar.com



Successful Fishing Made Simple™

Eagle Pub. 988-0143-631

Printed in USA 111902

© Copyright 2002
All Rights Reserved
Eagle Electronics